



BRAKE MOTORS

General catalogue





**Brake
motors**



ISO 9001:2000



Certified Quality System

GENERAL INFORMATION	4
PRODUCT RANGE: POWER AND POLE	5
MOTOR DESIGNATION	6
STANDARDS AND APPROVALS	7
CE MARK	7
UL - CSA STANDARDS AND APPROVAL	7
CCC CERTIFICATION	7
MOTOR IDENTIFICATION NAMEPLATE	8
TOLERANCES	9
STANDARD AND SPECIAL FLANGE	9
TYPE OF COSTRUCTIONS AND MOUNTING ARRANGEMENTS	10
ENCLOSURE RATINGS	11
BEARINGS	12
RECTIFIERS	13
VOLTAGE AND FREQUENCY SUPPLY	14
OPERATING AT 60 HZ	14
DUTY TYPES	15
MOTOR RUNNING ON INVERTER	16
BALANCING	17
NOISE	17
TEMPERATURE, ALTITUDE, HUMIDITY	18
PROTECTION DEVICES	19
BA SERIES GENERAL CHARACTERISTICS	21
BA SERIES BRAKE GROUP	22
AIR GAP ADJUSTMENT	22
BRAKE TORQUE ADJUSTMENT	22
PERMISSIBLE STARTING FREQUENCY WITH LOAD	22
BRAKE COIL WIRING CONNECTION	22
BRAKE TORQUE AND BRAKE SPRINGS COMPRESSION	23
TECHNICAL DATA SINGLE SPEED SINGLE WINDING MOTORS, (2, 4 POLES)	24
TECHNICAL DATA SINGLE SPEED SINGLE WINDING MOTORS, (6, 8 POLES)	25
TECHNICAL DATA TWO SPEED MOTORS SINGLE WINDING, (2 / 4 POLES)	26
TECHNICAL DATA TWO SPEED SINGLE WINDING MOTORS, (4 / 8 POLES)	27
TECHNICAL DATA TWO SPEED TWO WINDING MOTORS, (2 / 6 POLES)	28
TECHNICAL DATA TWO SPEED TWO WINDING MOTORS, (2 / 8 POLES)	29
TECHNICAL DATA TWOSPEED TWO WINDING MOTORS, (4 / 6 POLES)	30
TECHNICAL DATA TWO SPEED TWO WINDING MOTORS, (4 / 12 POLES)	31

- | | |
|----|--|
| 32 | TECHNICAL DATA TWO SPEED TWO WINDING MOTORS,
(2 / 12 POLES) |
| 32 | HOISTING MOTORS 4 / 16 POLES |
| 33 | BRAKE LININGS WEAR |
| 33 | STARTING AND BRAKING TIME |
| 34 | BA SERIES DIMENSIONS |
| | |
| 37 | BM SERIES GENERAL CHARACTERISTICS |
| 38 | BM BRAKE GROUP |
| 38 | AIR GAP ADJUSTMENT |
| 38 | PERMISSIBLE STARTING FREQUENCY WITH LOAD |
| 39 | BRAKE REACTION TIME AND RECTIFIER WIRING DIAGRAMS |
| 39 | BRAKING TIME CALCULATION |
| 40 | TECHNICAL DATA SINGLE SPEED SINGLE WINDING MOTORS
(2, 4 POLES) |
| 41 | TECHNICAL DATA SINGLE SPEED SINGLE WINDING MOTORS
(6, 8 POLES) |
| 42 | TECHNICAL DATA TWO SPEED SINGLE WINDING MOTORS
(2 / 4, 4 / 8 POLES) |
| 43 | TECHNICAL DATA TWO SPEED TWO WINDING MOTORS
(2 / 6, 2 / 8 POLES) |
| 44 | TECHNICAL DATA TWO SPEED TWO WINDING MOTORS
(4 / 6, 4 / 12 POLES) |
| 45 | BM SERIES DIMENSIONS |
| | |
| 46 | TRAVERSE MOTORS
WITH PROGRESSIVE START AND STOP (PV SERIES) |
| 48 | HOISTING MOTORS (BAPK SERIES) |
| 48 | PREMIUM BRAKE TORQUE (BAF SERIES) |
| 49 | FORCED COOLING MOTORS (SV SERIES) |
| 50 | BUILT-IN ENCODER MOTORS (E SERIES) |
| 51 | BAE SERIES DIMENSIONS |
| 52 | BMEAV SERIES DIMENSION |
| 53 | BUILT-IN INVERTER MOTORS |
| 54 | BUILT-IN INVERTER MOTORS SPECIFICATIONS |
| 55 | DOUBLE BRAKE MOTORS (BMBM SERIS) |
| 56 | BMBM SERIES DIMENSIONS |
| 57 | MOTORS FOR USA AND CANADA |
| 57 | MOTORS FOR AUSTRALIA AND NEW ZEALAND |
| 57 | MOTORS FOR CHINA |
| 58 | PACKAGING |
| 58 | TERMS AND CONDITIONS OF SALE AND WARRANTY |
| 59 | SPECIAL FEATURES AND OPTIONS |
| 60 | SPARE PARTS BA SERIES |
| 62 | SPARE PARTS BM SERIES |

MGM brake motors are asynchronous three-phase totally enclosed fan cooled motors. The motor brakes in case of power supply failure. The braking action is always obtained through a very quick and precise stop and it guarantees a safe and prompt intervention in case of an unintentional power supply failure.

The braking action is obtained without shaft axial sliding and it provides equal braking torque in both directions of rotation. MGM brake motors are particularly suitable for hoisting and traverse machines, tooling machinery, automatic and transfer machinery in textile, ceramic and packing fields and in all those situa-

tion where precision and quickness in braking are required.

MGM brake motors are designed and assembled as real brake motors. The perfect engineering and assembling combined with a strong and safe brake, make these motors very reliable.

As standard, on the IM B3 mounting (foot mounted), feet are integrated in the frame (they are not attached to the frame) making the motor very sturdy. This feature is very important on those brake motor applications where the stress during start/stop is very high.

The brake disc lining material is asbestos free with high friction coefficient and very

long lasting.

The motors are provided with IP 54 enclosure rating and insulation class F.

On request they can be provided with IP 55 or IP 56 enclosure ratings and with class H insulation .

All MGM motors are designed for inverter duty. On request it is possible to supply the motor with the encoder fitted on the second shaft end or to have the second shaft end ready to fit an encoder. For further information please refer to the encoder series section.

MGM brake motors series are: BA and BM.

BA series

The BA series consists of three phase, asynchronous brake motors totally enclosed fan cooled. The BA series range starts from 71 up to 225 frame size. As standard, the brake power supply is AC 3-phase. On request DC brake can be provided with a rectifier integrated in the terminal box. The rectifier is provided with an over-voltage and radio frequency emission protection device. All BA series motors are provided with manual brake release. The BA series cooling fan is fitted between the motor and the braking assembly. The brake moving element and the brake coil have a laminated magnetic nucleus to reduce losses and to allow very fast braking. BA series main features are a very quick braking action, both in unlocked and high torque braking, a constant braking time and a very high number of start/stop cycles also under severe applications.

BM series

The BM series consists of three phase, asynchronous brake motors totally enclosed fan cooled. The BM series range starts from 56 up to 160 frame size. As standard the brake power supply is DC with a rectifier integrated in the terminal box. The rectifier is provided with an over-voltage and radio frequency emission protection device. The cooling fan is fitted at non-drive shaft end. BM series main features are low braking noise, gradual acceleration during the motor start and stop and the reduced overall dimensions.

The BA and BM series are also available in the following main versions:

PV (BAPV, BMPV): with fly-wheel that allow progressive start and stop, particularly suitable for traverse application.

F (BAF): with double brake disc and extremely high brake torque.

AV-SV with forced cooling (BMAV with axial forced cooling, BASV with double radial forced cooling)

The table below shows the brake motors production range of BM, BA motor series.

Motor Type	Series	2 pole kW	4 pole kW	6 pole kW	8 pole kW	2 / 4 pole kW	4 / 8 pole kW	2 / 6 pole kW	2 / 8 pole kW	4 / 6 pole kW	4 / 12 pole kW S3 40%	2 / 12 pole kW S3 40%	4 / 16 pole kW S4 40% - 4 pole S4 25% - 16 pole
56 A	BM	0.09	0.06	0.04									
56 B	BM	0.12	0.09	0.06									
63 A	BM	0.18	0.12										
63 B	BM	0.25	0.18			0.22/0.15							
63 C	BM	0.37	0.22	0.09		0.26/0.17			0.18/0.04				
63 D	BM	0.45	0.30	0.12	0.07								
71 A	BM BA	0.37	0.25	0.18	0.08	0.25/0.18	0.13/0.07						
71 B	BM BA	0.55	0.37	0.25	0.11	0.37/0.25	0.18/0.09	0.25/0.08	0.25/0.06				
71 C	BM BA	0.75	0.55				0.22/0.12	0.35/0.1	0.35/0.07	0.18/0.11			
71 D	BM BA		0.65										
80 A	BM BA	0.75	0.55	0.37	0.18	0.65/0.45	0.25/0.18	0.37/0.12	0.37/0.09	0.25/0.18	0.25/0.05		
80 B	BM BA	1.1	0.75	0.55	0.25	0.88/0.62	0.37/0.25	0.55/0.18	0.55/0.12	0.37/0.25	0.37/0.07	0.45/0.07	
80 C	BM BA		0.90										
90 SA	BM BA	1.5	1.10	0.75	0.37		0.75/0.37	0.9/0.3		0.55/0.37	0.4/0.13	0.75/0.11	
90 SB	BM BA					1.3/0.9			0.75/0.18				
90 LA	BM BA	2.2	1.50	1.10	0.55	1.8/1.2		1.2/0.4	1.1/0.25		0.55/0.18	1.1/0.15	
90 LB	BM BA		1.85	1.30	0.65	2.2/1.5	1.1/0.6	1.4/0.5	1.3/0.3	0.75/0.55	0.75/0.22		
90 LC	BM BA		2.2										
100 LA	BM BA	3.0	2.2	1.50	0.75	2.2/1.5		1.6/0.6	1.6/0.4	1.1/0.8	0.9/0.25		
100 LB	BM BA		3.0	1.85	1.1	3.1/2.3	1.6/0.9	2.2/0.8	2.2/0.5	1.5/1.0	1.1/0.35	1.85/0.25	
112 MB	BM BA	4.0	4.0	2.2	1.5	4.5/3.3	2.2/1.2	3.0/1.0	3.0/0.8	2.0/1.3	1.5/0.45	3.0/0.45	
112 MC	BM BA	5.5	5.5										
132 SA	BM BA	5.5									2.5/0.8		
132 SB	BM BA	7.5	5.5	3.0	2.2	5.0/4.5	3.0/2.0	4.0/1.3	4.0/1.1	2.2/1.5		4.0/0.65	
132 MA	BM BA	9.2	7.5	4.0		6.0/5.0	4.0/2.7	5.5/1.8	5.5/1.5	3.0/2.2	3.0/1.0	5.5/0.9	2.8/0.7
132 MB	BM BA	11.0	9.2	5.5	3.0	7.5/6.0	6.0/4.0	7.0/2.2	7.0/1.8	3.7/2.5	4.0/1.3	7.0/1.1	4.0/1.1
132 MBX	BM BA		11.0										
160 MA	BM BA	11.0	9.2		4.0	9.5/8.0							5.5/1.3**
160 MB	BM BA	15.0	11.0	7.5	5.5	11.0/9.0	6.5/4.5	8.0/2.5	8.0/2.2	5.5/3.7	4.8/1.6	8.0/1.3**	7.3/1.8**
160 LA	BM BA	18.5	15.0	9.2	7.5	13.0/11.0	9.5/6.0	11.0/3.6	11.0/3.0			11.0/1.8**	
160 LB	BM BA			11.0						7.5/5.0	7.3/2.4		10.0/2.5**
180 LA	BA	22.0	18.5			17.0/14.0	11.0/8.0			11.0/7.5			13.2/3.0
180 LB	BA		22.0	15.0	11.0	20.5/17.0	14.0/9.0	16.0/6.5	16.0/4.0	13.0/8.8		16.0/2.6	
200 LA	BA	30.0		18.5	15.0		18.0/11.0						
200 LB	BA	37.0	30.0	22.0		24.0/20.0	21.0/13.0		18.5/4.5	15.0/10.5			16.0/4.0
225 S	BA		37.0			37.0/30.0	30.0/18.0		24.0/6.0				19.0/4.8
225 M	BA		45.0	30.0	22.0	45.0/35.0	35.0/25.0		30.0/7.5				24.0/6.0
225 MX	BA			37.0									

** Powers available for BA series only

Note: All the above motors can be provided in the standard execution, without the brake also with a servo fan, built-in encoder or built-in inverter.

The following technical characteristics are used to correctly identify MGM motors:

Series	BM, BA ¹	example: BA
Frame size	56 - 225 mm	example: 71
Power and poles	<ul style="list-style-type: none"> 0.04 - 45 kW 2 - 4 6 - 8 2 - 4 4 - 8 2 - 6 2 - 8 4 - 6 4 - 12 poles ² 	example: 0.37 kW 4 poles or B 4 (see technical data)
Mounting	See mounting section	example: IM B5
Voltage and frequency	According to customer request	example: 230/400V 50 Hz
Brake supply	<ul style="list-style-type: none"> AC or DC ³ Single or double terminal board box ⁴ 	example: AC brake coil, double terminal board box for separate brake supply
Insulation class	F or H	example: class F
Enclosure	IP54, IP55, IP56	example: IP 54

It is necessary to indicate any special features or options not supplied as standard (see page 59), such as reduced diameter flanges, thermal protectors, tropical environment execution, etc. Unless otherwise specified, the brake supply voltage is the same as the motor voltage. Unless otherwise specified, the DC brake voltage supply is 230V 50/60 Hz.

1 The BM, BA series are also available in the versions BMPV, BAPV with soft start and stop suitable for traversing, and the version BMSV, BASV with forced cooling fan. The BA series is also available in the version BAF, with double brake disc and premium brake torque.

2 In two speed motors, the model number is followed by the letter D on motors with Dahlander winding, and by the letters DA on motors incorporating two separate windings (i.e. BADA 71 B 2/8).

3 BA series motors are available with both DC and AC brakes while BM series motors are available with only DC brakes. DC brake motors with power supply higher than 24 Volts have as standard a rectifier with emission suppression.

4 Single speed motors can be provided with a single terminal board box with the motor and brake power terminals connected in parallel, or with a double terminal board, having the motor supplied separately from the brake. Unless otherwise specified, single speed motors up to 112 frame size are provided with just one terminal board. Motors with frame size 132 and above are provided as standard feature with a double terminal board box. On two speed motors, the motor power supply is always separate from the brake power supply. On single speed motors with separate brake power supply a double terminal board box has to be provided. A double terminal board box also has to be provided on motors with the following options or auxiliary devices: thermo protectors, thermistors (PTC), standstill heaters, forced cooling, IP 56 enclosure, EMI filters, DC brake with brake power supply higher than 254V, brake voltage different from motor voltage, motor voltage 400/690V 50Hz, encoder, microswitch, side terminal box.

Example BA 71 B4, 230/400V 50 Hz, class F, IP 54, IM B5, AC brake coil, double terminal board box.

Description	IEC	GENELEC	CEI / UNEL	BS	NFC	DIN / VDE	DEC
Ratings and operating characteristics	IEC 34 - 1	EN 60034 - 1	CEI 2 - 3	BS 4999 - 101	NFC 51 - 111 NFC 51 - 100	VDE 0530 - 1	UNE 20113-1
Methods for determining losses and efficiency using tests	IEC 34 - 2	EN 60034 - 2	CEI 2 - 6	BS 4999 - 102	NFC 51 - 112	VDE 0530 - 2	UNE 20116
Cooling methods for rotating electrical machines	IEC 34 - 6	EN 60034 - 6	CEI 2 - 7	BS 4999 - 21		DIN IEC 34 - 6	UNE 20125
Terminal markings and direction of rotation of rotating machines	IEC 34 - 8	EN 60034 - 8	CEI 2 - 8	BS 4999 - 3	NFC 51 - 118	VDE 0530 - 8	UNE 203001 - 8
Characteristics of mountings and types of installation	IEC 34 - 7	EN 60034 - 7	CEI 2 - 14	BS 4999 - 22	NFC 51 - 117	DIN IEC 34 - 7	UNE 20112
Starting behaviour of asynchronous three phase single speed cage motors, at 50 Hz and with power supply up to 660 V	IEC 34 - 12	EN 60034 - 12	CEI 2 - 15	BS 4999 - 112		VDE 0530 - 12	
Classification of protection degree of rotating electrical machines	IEC 34 - 5	EN 60034 - 5	CEI 2 - 16	BS 4999 - 20	NFC 51 - 115	VDE 0530 - 5	UNE 20111 - 5
Mechanical vibrations of machines with shaft height from 56 mm. Measurement, assessment and limits of vibration intensity	IEC 34 - 14	EN 60034 - 14	CEI 2 - 23	BS 4999 - 142	NFC 51 - 111	DIN ISO 2373	
Fixing dimensions and rating powers for IM B3 motors and derivatives	IEC 72	HD 231 EN 50347	UNEL 13113 CEI 2 - 31	BS 4999 - 10	NFC 51 - 110	DIN 42673	UNE 20106
Fixing dimensions and rating powers for IM B14 motors and derivatives	IEC 72	HD 231 EN 50347	UNEL 13117/13118 CEI 2 - 31	BS 4999 - 10	NFC 51 - 120	DIN 42677	UNE 20106
Noise level, limit values	IEC 34 - 9	EN 60034 - 9	CEI 2 - 24	BS 4999 - 51	NFC 51 - 119	VDE 0530 - 9	

CE Mark

MGM brake motors have the **CE** mark on the nameplate to indicate the conformity to the requirements of 73/23 EEC "Low Voltage Directive" and 89/336 EEC "Electromagnetic Compatibility Directive", with their subsequently amendments EEC 92/31 and 93/68 EEC.

CSA approval and UL standards

On request MGM motors can be provided with cCSAus approval in conformity with the requirements of UL 1004 "Electric motors" and CSA C 22.2 No. 100 "Motors and generators" for the North American market. The approved motors show the  mark on the nameplate.

CCC approval

On request MGM motors can be provided with CCC (China Compulsory Certification) approval for the Chinese market. The approved motors show the  mark on the nameplate.

Motor identification nameplate

Every motor is provided with an identifying nameplate, on which specific motor information is given. Motor nameplates are shown below with motor data and explanatory notes. The nameplate shown on the left is used for single speed motors while the nameplate on the right is used for two speed motors.

		MGM motori elettrici s.p.a.			
Serravalle Pistoiese (PT) ITALIA				2771	
Mot. 3 ~	1	IP	2	Ins. CL	3
				Kg	4
TYPE	5		N	6	
○	Brake Max. Nm	7	I Brake	8	
	9				
Hz 50 kW	10		Hz 60 kW	17	
cos φ	11	min ⁻¹	12	cos φ	18
				min ⁻¹	19
△	13	Y	15	VOLT	20 22
	14	16	AMP	21 23	
IEC 34-1 (1994)					

		MGM motori elettrici s.p.a.			
Serravalle Pistoiese (PT) ITALIA				2771	
Mot. 3 ~	1	IP	2	Ins. CL	3
				Weight Kg	4
TYPE	5		N	6	
○	9				
	Brake Max. Nm	7	I Brake	8	
Hz 50 kW	10		min ⁻¹	12	
V	24	cos φ	11	A 25	
Hz 60 kW	17		min ⁻¹	19	
V	26	cos φ	18	A 27	
IEC 34-1 (1994)					

- 1 Duty type
- 2 Enclosure rating
- 3 Insulation Class, the letters TR following the insulation class means tropicalized treatment
- 4 Weight (Kg)
- 5 Motor type Designation
- 6 Serial Number
- 7 Maximum Static Brake Torque obtainable with proper regulation of the springs (Nm)
- 8 Brake Current (A)
- 9 Brake Voltage Supply (V). On brake motors with D.C. brake the voltage supply follows the note "DC BRAKE". On brake motors with AC brake the symbol "V_b = V_m" indicates that the motor and brake have the same voltage supply. For motors with additional cooling fans, the fan voltage supply is shown in this location, preceded by the letters "VENT". The letters "TP" indicate the presence of bimetallic thermal protectors, "TM" indicate thermistors, and "SCALD" indicates anti-condensation heaters, all followed by the voltage supply.
- 10 Rated Power (kW) at 50 Hz
- 11 Power Factor at 50 Hz
- 12 Motor Speed (RPM) at 50 Hz
- 13 Motor Voltage Supply at 50 Hz, Delta connected
- 14 Motor Amps at 50 Hz, Delta connected
- 15 Motor Voltage Supply at 50 Hz, Star connected
- 16 Motor Amps at 50 Hz, Star connected
- 17 Rated Power (kW) at 60 Hz
- 18 Power Factor at 60 Hz
- 19 Motor Speed (RPM) at 60 Hz
- 20 Motor Voltage Supply at 60 Hz, Delta connected
- 21 Motor Amps at 60 Hz, Delta connected
- 22 Motor Voltage Supply at 60 Hz, Star connected
- 23 Motor Amps at 60 Hz, Star connected

Electromechanical Characteristics

The table below, describes the electromechanical tolerances concerning electric motors, according to the IEC 34-1 standard (EN 60034-1).

Parameter	Tolerance	
Efficiency	- 0.15 (1 - η)	Rated power ≤ 50 kW
Power Factor	$\cos\varphi$	- (1 - $\cos\varphi$) / 6 min 0,02 - max 0,07
Slip	$\pm 30\%$	Rated power <1kW
	$\pm 20\%$	Rated power ≥ 1 kW
Locked Rotor Current	+20%	
Moment of Inertia	$\pm 10\%$	of the guaranteed value
Locked Rotor Torque	- 15%	of the guaranteed value
	+25%	of the guaranteed value (Upon request it is possible to exceed the +25% value)

Mechanical tolerances

The table below describes the mechanical tolerances concerning electric motors, according to the standard IEC 72.

Dimension	Tolerance	
Shaft Height	- 0,5 mm	
Flange Spigot	j6 h6	for motors up to 132 frame size for motors of 160 frame size and above
Shaft End Diameter	j6 k6 m6	\varnothing from 39 mm up to 28 mm \varnothing from 38 mm up to 48 mm \varnothing from 55 mm up to 60 mm

Standard and special flange

The table below shows the dimension of the standard and special flange and shaft sorted by frame size.

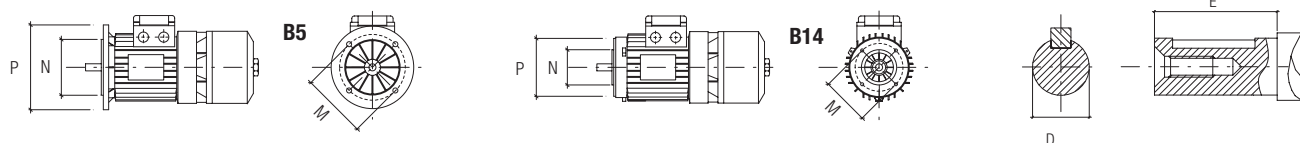

Motor frame size	Shaft drive end dimension (DxE) (mm)	Flange type	Flange dimension (P/M/N) (mm)
BM 56	9x20	B5 (standard)	120/100/80
BM 56	9x20	B14 (standard)	80/65/50
BM 63	11x23	B5 (standard)	140/115/95
BM 63	11x23	B14 (standard)	90/75/60
BM 63	11x23	B14-R (56)	(80) 90/65/50 ***
BA 71	14x30	B5 (standard)	160/130/110
BA 71	14x30	B5-R (56)*	120/100/80
BA 71	14x30	B5-R/M (63)*	140/115/95
BA 71	14x30	B5-M	200/165/130
BA 71	14x30	B14 (standard)	105/85/70
BA 71	14x30	B14-R	(90) 105/75/60 ***
BA 80	19x40	B5(standard)	200/165/130
BA 80	19x40	B5-R	160/130/110
BA 80	19x40	B14	120/100/80
BA 80	19x40	B14-R	(105) 120/85/70 ***
BA 90	24x50	B5(standard)	200/165/130
BA 90	24x50	B5-R	160/130/110
BA 90	24x50	B14(standard)	140/115/95
BA 90	24x50	B14-R	(120) 140/100/80 ***
BA 100	28x60	B5(standard)	250/215/180
BA 100	28x60	B5-R **	200/165/130
BA 100	28x60	B14(standard)	160/130/110
BA 112	28x60	B5 (standard)	250/215/180
BA 112	28x60	B14(standard)	160/130/110
BA 132	38x80	B5(standard)	300/265/230
BA 132	38x80	B5-R	250/215/180
BA 132	38x80	B14(standard)	200/165/130
BA 160	42x110	B5(standard)	350/300/250
BA 180	48x110	B5(standard)	350/300/250
BA 200	55x110	B5(standard)	400/350/300
BA 225	60x140 (4/6/8 Poles)	B5(standard)	450/400/350
BA 225	55x110 (2 Poles)	B5(standard)	450/400/350

Notes: * This type of flange requires a special shaft therefore it isn't interchangeable with the standard flanges. This flange increases the motor length (Q) by 25mm.

** This type of flange requires a non standard bearing while the shaft remains the standard one.

*** The difference between the dimension of the reduced flange and the standard one (in brackets) doesn't affect the correct motor assembly.

Type of construction and mounting

The table below shows the most important types of mounting arrangements according to IEC 34-7 (EN 60034-7) standard. Two systems of classification are provided: code 1 (the alpha-numeric designation) and code 2 (the all numeric designation).

Horizontal shaft Mountings

IM B3

IM 1001

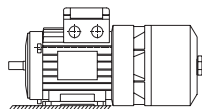

Foot mounted motor, feet down.

IM B5

IM 3001

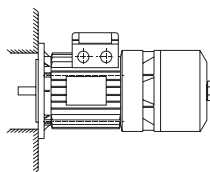

Flange mounted on D-End side.

IM B35

IM 2001

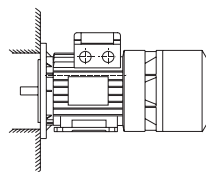

Foot and flange mounted motor.

IM B6

IM 1051

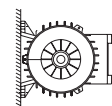

Foot mounted motor. Feet left (viewed from D-End)

IM B7

IM 1061

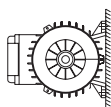

Foot mounted motor. Feet right (viewed from D-End)

IM B8

IM 1071

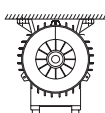

Foot mounted motor. Feet up (viewed from D-End)

IM B14

IM 3601

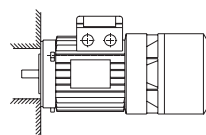

Face mounted. Flange with threaded holes and spigot

IM B34

IM 2101

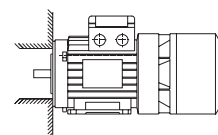

Face and foot mounted. Flange with threaded holes and spigot.

Vertical shaft Mountings

IM V1

IM 3011

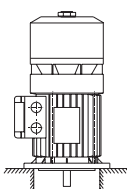

Flange mounted. Shaft down.

IM V15

IM 2011

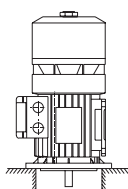

Foot and flange mounted motor. Shaft down.

IM V3

IM 3031

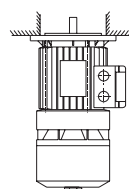

Flange mounted. Shaft up.

IM V36

IM 2031

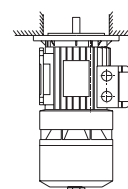

Foot and flange mounted motor. Shaft up.

IM V5

IM 1011

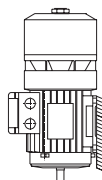

Foot mount. Shaft down.

IM V6

IM 1031

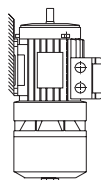

Foot mount. Shaft up.

IM V18

IM 3611

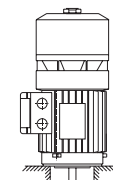

Face mount. Shaft down. Flange with threaded holes and spigot.

IM V19

IM 3631

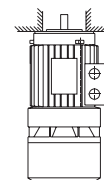

Face mount. Shaft up. Flange with threaded holes and spigot.

Notes for information about the classifications of other types of construction and mounting please contact MGM.

The enclosure rating of the motor has to be suitable to the environment conditions the motor operates in. According to the IEC34-5 (EN 60034-5) standard the designation of the protection degree is expressed by means of a symbol made up of two letters (IP) followed by a two digit number. The first digit indicates the protection degree provided by the motor enclosure in contact with parts in motion, electrically energized, or against the penetration of foreign bodies. The second digit indicates the protection degree of the motor enclosure against damages caused by the penetration of liquids.

IP First digit Second digit

First digit

- 0** No protection.
- 1** The machine is protected against the penetration of solid bodies greater than 50 mm in diameter (for example, protection against the accidental touch of a hand).
- 2** The machine is protected against the penetration of solid bodies greater than 12 mm in diameter.
- 3** The machine is protected against the penetration of solid bodies greater than 2.5 mm in diameter.
- 4** The machine is protected against the penetration of solid bodies greater than 1mm in diameter.
- 5** The machine is protected against the penetration of dust. The penetration is not completely avoided, but should not compromise the good functioning of the machine.
- 6** Dust tight machine

Second digit

- 0** No protection.
- 1** Vertical dropping of water on the machine will not result in damaging effects.
- 2** Vertical dropping of water on the machine will not result in damaging effects when the machine is not inclined more than 15° from its normal position.
- 3** Water or rain dropping on the machine at an angle up to 60° will not result in damaging effects.
- 4** Water spraying on the machine from any angle will not result in damaging effects to the machine.
- 5** Water jets on the machine from any angle will not result in damaging effects to the machine.
- 6** Waves of water will not result in damaging effects to the machine.
- 7** Immersing the machine in water under specific conditions of pressure and time will not cause the ingress of a damaging quantity of water.
- 8** Immersing the machine permanently in water under conditions of pressure and time given by the manufacturer will not result in damaging effects.

MGM brake motors come with standard IP54 enclosure rating. On request, motors can be provided with IP55 or IP56 enclosure rating. For use in standard industrial environments IP54 is sufficient. For outdoor applications or for application that involve contact with water, protection degree IP55 or IP56 is advisable. It's always advisable to protect the motor as much as possible. During the installation stage secure the proper tightening of the cable gland and the insertion of the wire from the bottom upwards. On request, for outdoor vertical mounting with shaft down, a rain roof (BM series) or a special brake cover (BA series) are available. MGM motors are also available with special corrosion protection for hard environment application such as marine application and tough processing applications in poultry, meat, dairy, snack foods and pharmaceuticals. On request motors can be provided with the following option:

- Bearings for high/low temperatures
- Oil seal on drive shaft end
- Special frame/plates corrosion-resistant surface treatment and/or epoxy painting
- Drain holes
- Stainless steel nameplate
- Stainless steel shaft-end
- Stainless steel or zinc plated brake friction surface
- Stainless steel nuts, bolts, tie rods and screws

Contact MGM for additional information.

All M.G.M. brake motors are equipped with double seal ball bearings. The bearings are lubricated for life, washers are made of synthetic rubber very resistant to oil and to wear.

Frame Size	Bearing Type	
	Drive End (D)	Non-Drive End
56	6201 - 2RZ	6201 - 2RZ
63	6202 - 2RS1	6202 - 2RS1
71	6203 - 2RS1	6203 - 2RS1
80	6204 - 2RS1	6204 - 2RS1
90	6205 - 2RS1	6205 - 2RS1
100	6206 - 2RS1	6206 - 2RS1
112	6306 - 2RS1	6306 - 2RS1
132	6308 - 2RS1	6308 - 2RS1
160	6309 - 2RS1	6309 - 2RS1
180	6310 - 2RS1	6310 - 2RS1
200	6312 - 2RS1	6310 - 2RS1
225	6313 - 2RS1	6312 - 2RS1

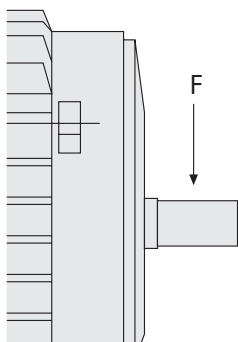

The nominal bearings lifetime is expressed in working hours according to the international bearings lifetime calculations, and it depends on the applied load, temperature and speed. The maximum allowed overhung load (N) acting at the middle of the output shaft (F in the sketch), for the different lifetimes at different speeds, can be obtained from the table below for every motor frame size.

Frame Size	20000 Hours				40000 Hours			
	2 pole	4 pole	6 pole	8 pole	2 pole	4 pole	6 pole	8 pole
56	320	410	470	520	260	320	370	410
63	410	520	600	650	330	410	470	520
71	500	630	720	800	400	500	570	630
80	660	840	950	1200	500	660	750	840
90	720	900	1000	1300	550	720	820	900
100	1000	1250	1400	1800	790	1000	1100	1250
112	1450	1850	2100	2650	1150	1450	1650	1850
132	2150	2700	3100	3950	1700	2150	2450	2700
160	2700	3400	3900	4900	2100	2700	3050	3400
180	3250	4100	4700	5980	2600	3250	3750	4100
200	4300	5450	6250	6850	3400	4300	4950	5450
225	5160	6540	7450	8200	4000	5050	5850	6400

Motors with a DC brake are provided as standard with a rectifier located inside the terminal box. Rectifiers are fitted with an over-voltage and radio frequency emission protection. The diagrams below show different types of rectifiers available on MGM motors. The M type rectifier is also suitable to be mounted inside an electric panel. All MGM rectifiers can be connect with two wiring diagrams according to brake intervention time needed (see pages 22 and 39).

Type C110

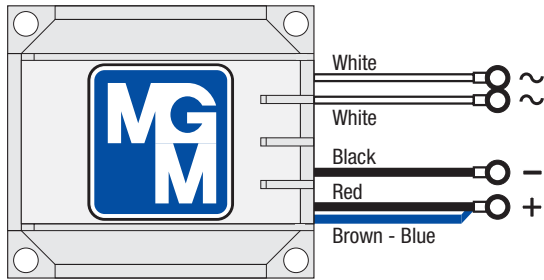

RESIN COULOR: Green
INPUT: 110V ~ OUTPUT: 103V =

Type C230

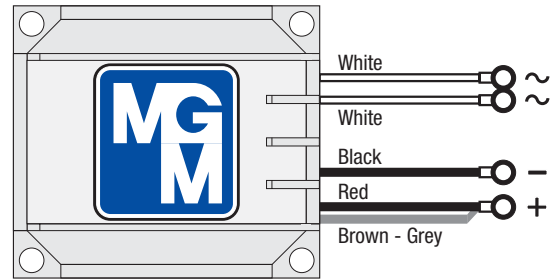

RESIN COULOR: Blue
INPUT: 230V ~ OUTPUT: 103V =

Type Q110

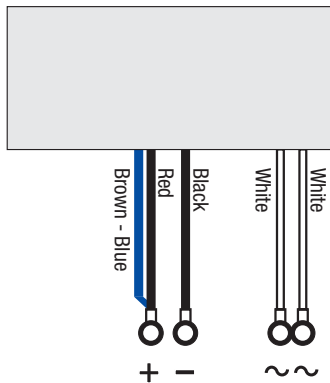

RESIN COULOR: Green
INPUT: 110V ~ OUTPUT: 103V =

Type Q230

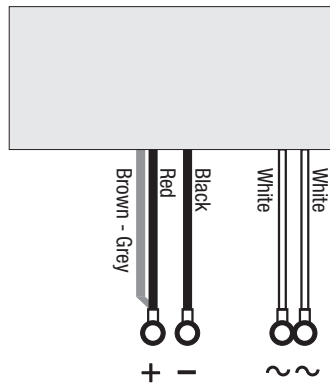

RESIN COULOR: Blue
INPUT: 230V ~ OUTPUT: 103V =

Type Q400

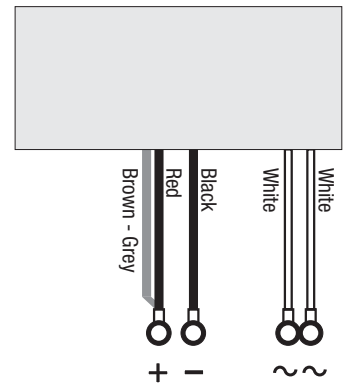

RESIN COULOR: Yellow
INPUT: 400V ~ OUTPUT: 180V =

Type M110

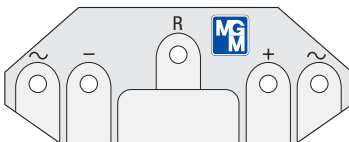

RESIN COULOR: Green
INPUT: 110V ~ OUTPUT: 103V =

Type M230

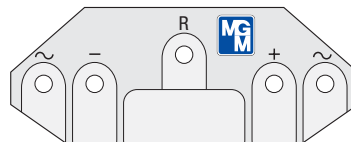

RESIN COULOR: Blue
INPUT: 230V ~ OUTPUT: 103V =

Type M400

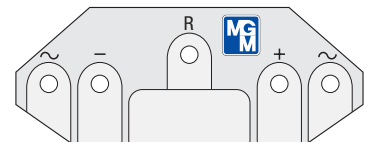

RESIN COULOR: Yellow
INPUT: 400V ~ OUTPUT: 180V =

Motor Voltage and Frequency Supply

MGM motors are provided with a standard voltage rating of 230/400V±10% 50 Hz (IEC 38, CENELEC HD 472, CEI 8-6) “European voltage”. On request they can be provided with different operating voltages.

The operating voltages at 50Hz and 60Hz are clearly indicated on the motor nameplate (see motor nameplate section). MGM motors are suitable to work within a voltage variation of 10% on the nameplate voltage. The available rated voltages are shown in the table below under “Nameplate voltage” at 50 Hz and 60 Hz, while the corresponding voltages on which the motor is able to run are shown under “Usable voltage”.

Nameplate voltage		Usable voltage	
230 / 400 50	277 / 480 60	240 / 415 50	220 / 380 50 265 / 460 60
190 / 330 50	220 / 380 60	208 / 360 60	230 / 400 60
208 / 360 50	254 / 440 60	200 / 346 50	240 / 415 60
400 / 690 50	480 / 830 60	380 / 660 50	415 / 717 50
	230 / 460 60	200 / 400 50	
	330 / 575 60		

It is important to understand the torque vs. RPM curves for different voltages supplied to the motor (on the side) particularly for those motors running under heavy duty. If you are supplying the brake with a lower voltage than the nominal one, the air gap has to be adjusted more frequently than in the case of nominal voltage supply in order to guarantee a constant high brake performance.

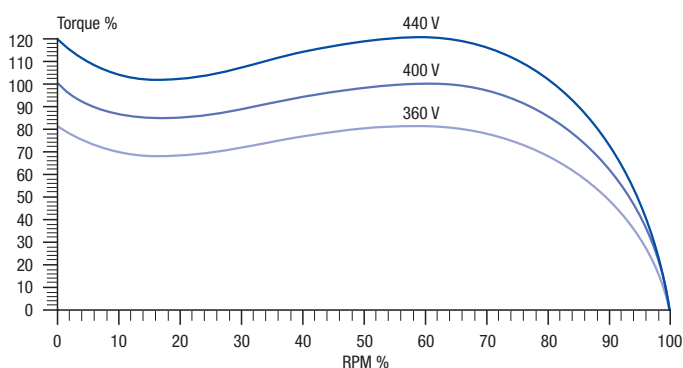

Operating at 60Hz

MGM motors with rated voltage of 230/400V 50Hz maintain the same rated and starting torque if operating at 277/480V 60 Hz while the RPM increase by about 20% (see torque vs. RPM comparing curves 1 and 2 here below).

The AC brake coil on BA series works equally well if operating either at 230/400V 50Hz or at 277/480V 60Hz. The DC brake coil with nameplate voltage of 110V, 230V or 400V on BM and BA series has to be supplied at 110V, 230V or 400V single phase respectively both at 50 Hz or 60 Hz (i.e. a 230V brake can be supplied single-phase at 230V 50Hz or at 230V 60 Hz).

MGM is able to provide motors and brake coil suitable for operating on 220/380V 60Hz power supply. It is not advisable to run motors designed for 230/400V 50Hz and 277/480V 60Hz on 220/380V 60Hz voltage supply as the power remains the same, but the starting torque is reduced by 35% (see curves 1 and 3 here below).

MGM strongly recommends not to use a 277/480V 60Hz (230/400V 50Hz) AC brake coil on 220/380V 60Hz power system as it results in a significant loss of performance.

DC brakes with a rated voltage of 230V 50Hz can be used on 220V 60Hz and those with a rated voltage of 400V 50Hz on 380V 60Hz power system.

The diagram below shows different curves (torque vs. RPM) for a 230/400V 50Hz (277/480V 60Hz) rated voltage motor running on different power systems.

- ① 230/400V 50Hz (277/480V 60Hz) rated voltage motor running on 230/400V 50 Hz power system.
- ② 230/400V 50Hz (277/480V 60Hz) rated voltage motor running on 277/480V 60 Hz power system.
- ③ 230/400V 50Hz (277/480V 60Hz) rated voltage motor running on 220/380V 60Hz power system.

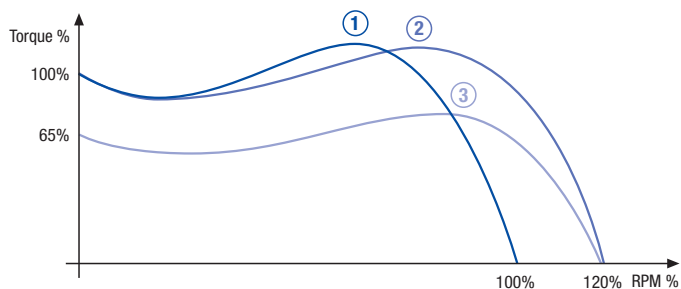

It is important to point out that, if running the motor at 60Hz instead of 50 Hz, the maximum number of starts reduces by about 15-20%, and the noise level increases by about 3dB due to the increased speed of the cooling fan.

The most common duty types are described in this paragraph and a method to calculate the permissible power rise-up is given. Please contact MGM for different types of duty.

Continuous duty S1

The motor operates with constant load for a period of time sufficient to achieve the thermal equilibrium.

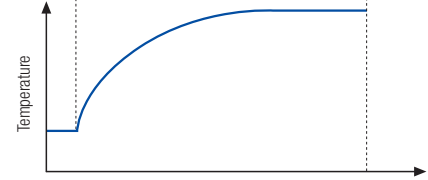
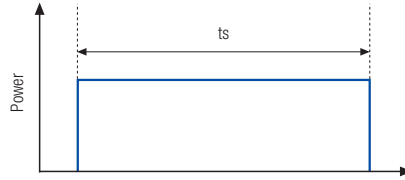

Limited length duty S2

The motor operates with constant load for a limited period of time not sufficient to achieve a thermal equilibrium. The remaining period of the cycle is a rest period, during which the motor cools down to the ambient temperature again.

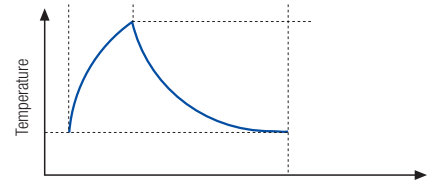
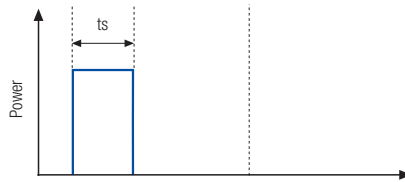

Periodic intermittent duty S3

The motor follows a cycle including an operation period with constant load (t_s) and a rest period (t_r). The synthetic indication of the duty is given by the intermittent percentage ratio related to a period of time, which usually is 60 min. (f.e. 15% - 60 min.).

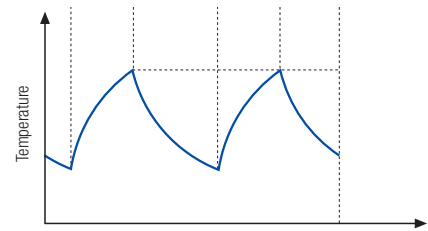
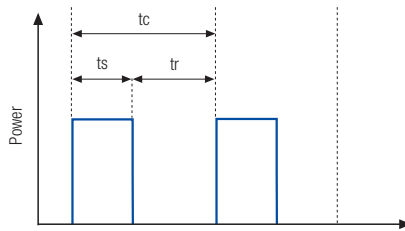

$$\text{Intermittence ratio} = \frac{t_s}{t_s + t_r} \cdot 100\%$$

A motor designed for S1 duty but running on S2 or S3 duty can provide a power output higher than the rated one on S1 duty. However, the starting torque remains the same on all duties.

The permissible approximate output power for single speed motors can be calculated as follows:

$$\text{Power (S2 or S3 duty cycle)} = K \cdot \text{Nominal power}$$

Where K is a coefficient given by the following diagrams:

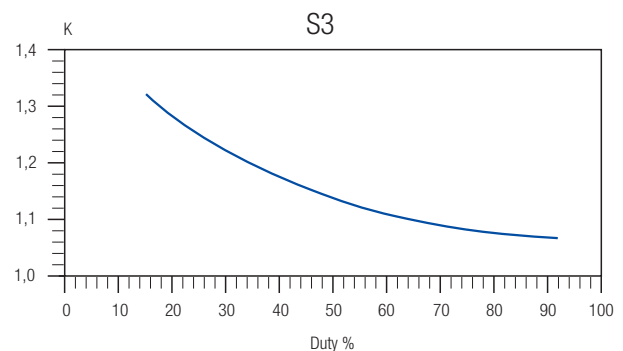
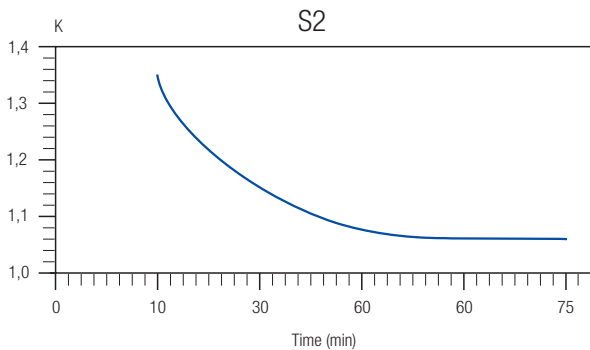

MGM motor running on Inverter Duty (Frequency Converter).

All MGM motors are designed to be suitable for inverter duty. See below to understand the motor operating under inverter control:

The motor speed depends on the power supply frequency. Basically the inverter works converting the power input from the line with a fixed amplitude and frequency into a voltage supply with a variable amplitude and frequency suitable to control the motor speed. Inverter can't generate an output voltage higher than the input voltage while it can increase the frequency above the input rated value; Constant torque regulation range means a range where the inverter is able to keep the nominal ratio of voltage to frequency constant; in our diagram this range is up to 50 Hz.

Constant power (or flow) regulation range means a range where the inverter can increase frequency (and so the motor rotation speed), without voltage increase to the motor (and consequently the torque); in our diagram this range exceeds 50 Hz;

Operating diagram shows the percent values of the torque available both in continuous and overloading running; When the motor is running within constant torque regulation range (frequency below 50 Hz), it is necessary to check that continuous slow running does not cause overheating; in that case servo fan (see operating diagram) is needed. When the motor is running within constant power regulation range (frequency above 50 Hz), it is necessary to check if the torque required by the load does not exceed the torque indicated on the operating diagram, otherwise malfunction and eventual intervention of inverter overload protection devices could occur.

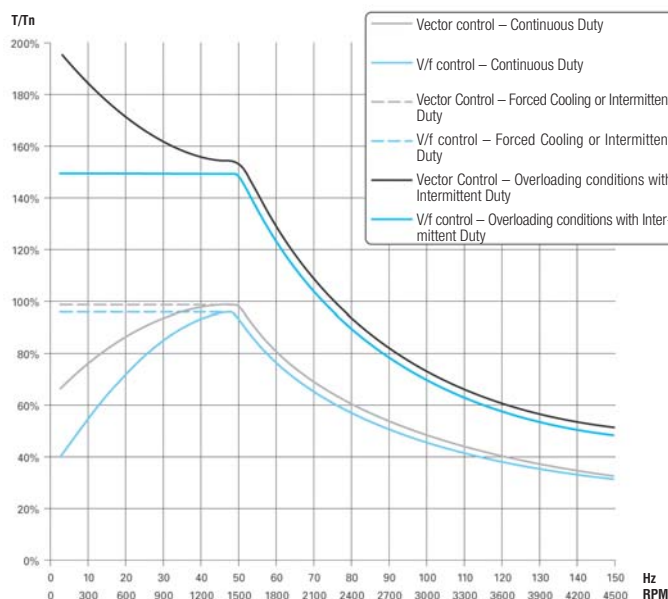

The brake should be supplied separately from the motor on brake motors controlled by inverters, to ensure the proper working of the brake coil. In this case the double terminal board box option must be requested. On brake motors with AC brake coil, it is also advisable to use a safety overload cutout (MGM type RCO4) on the power supply of the brake coil.

The starting torque of a motor running on inverter is different from the one of a motor connected directly on line. Be sure to select an inverter with technical specifications suitable for the work load of the machine it is intended to be used on.

An inverter changes the electrical wave pattern to the motor from purely sinusoid to switching typical shape. Because of undesirable harmonic components added to the underlying power supply, a motor controlled by an inverter has higher losses, and an increased vibration and noise level. The efficiency reduction varies according to the type of inverter used. In the figure on the right the harmonic content of the power supply of a motor under inverter can be seen (blue indicates the underlying power supply, grey indicates the harmonics).

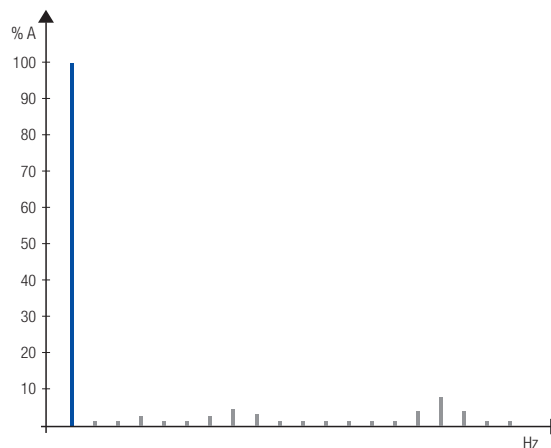

Please contact MGM technical staff when using inverters with power supply higher than 400V or when using long cables between the motor and the inverter as both situations can be critical for the motor winding insulation system.

The interference generated by electronic power devices such as inverters, can influence equipment sensitive to interference, such as computers, load cells, photocells, temperature regulators, magnetic intrusion switches, or capacitance grounding circuits, and control wiring.

Whenever it is necessary to reduce the interference caused by the inverter the following practical suggestions should be implemented.

Disturbances are highest nearby the inverter, and can be attenuated by increasing the distance. Sensitive devices should be kept at least 50 cm from the frequency converter. The power wiring should be kept at least 50 cm away from the control wiring. Use power cables as short as possible. Power cables longer than 10 m is a strong source of disturbances, and can cause malfunctions. An EMI filter may be necessary on the power supply line.

Information on the correct wiring of the inverter to the motor should be obtained from the inverter manufacturer.

Balancing

MGM brake motors are balanced with a half key applied to the motor shaft ends, according to the IEC standard 34-14 (GENELEC HD-53.14S1, CEI 2-23). Reducing vibrations is important both to avoid motor damage, especially to the bearings, and to avoid damage to the machinery to which the motor is coupled. It is advisable to balance the parts of the attached machinery (the coupling, the pulleys, etc.) in order to avoid vibrations. The maximum permissible vibration intensities for different frame size, according to the norm IEC 34-14, can be seen in the table below. As standard motors are supplied with normal class balancing, upon request they can be supplied with reduced or special class balancing.

Class	Rated speed (RPM)	Effective maximum values of vibration speed (mm/s) depending on frame size H	
		56 mm ≤ H ≤ 132 mm	132 mm ≤ H ≤ 225 mm
N (Normal)	600 ≤ n ≤ 3600	1.8	2.8
R (reduced)	600 ≤ n ≤ 1800 1800 < n ≤ 3600	0.71 1.12	1.12 1.8
S (Special)	600 ≤ n ≤ 1800 1800 < n ≤ 3600	0.45 0.71	0.71 1.12

Noise

The noise of a running electric motor is mainly generated by the magnetic field, the bearings and the cooling system. The most relevant noise level is generated by the cooling fan. Technical data sheets report the values of the sound pressure in dB (A) according to ISO 1680. The above mentioned values should be increased by about 3-4 dB on motors operating at 60 Hz. On request it is possible to provide motors with low noise level. During the braking action the noise level depends on the air gap (distance between the brake coil and the brake moving element). Periodic air gap adjustment provides lower noise levels.

The standard electrical specifications of the motors are referred to continuous duty (S1), nominal voltage, nominal frequency (50 to 60 Hz), an ambient temperature of max 40 °C and installation elevation up to 1000 m. above sea level. If ambient temperature is higher than 40 °C the permissible output power should be reduced by a percentage of the rated value (see the table below).

Environment Temperature °C	40	45	50	55	60
Permissible Output Power as percentage of the Rated Power.	100	96,5	93	90	86,5

If ambient temperature is higher than 60 °C or lower than -30 °C please contact the MGM technical office. If the motor is going to work at an elevation higher than 1000 m. above sea level, the permissible output power should be reduced by percentage of the rated value (see the table below).

Elevation above the see level	1000	1500	2000	2500	3000	3500	4000
Permissible Output Power as percentage of the Rated Power.	100	97	94,5	92	89	86,5	83,5

Motors working in low temperature or high moisture environments

If a motor has to be used in an environment where the temperature is less than -15 °C, in high moisture or where abrupt temperature changes can occur, it is advisable to use anti-condensation heaters. This recommendation is particularly important where there are long pauses between work cycles, which may cause abundant condensation on the motor windings. It could permeate the windings and cause short circuits. This occurs mostly on larger motors, which contain more air volume inside, allowing more humidity to condense. Two anti-condensation heaters are fitted on the windings heads in order to increase the internal motor temperature so as to prevent the air condensation.

Three different types of heaters are used according to the motor size. The wiring leads of the heaters are connected to the terminal board located in the terminal box. The presence of anti-condensation heaters is shown by the writing "SCALD" followed by the required supply voltage in the field 9 of the nameplate (according to nameplate paragraph). The heaters must not be supplied during the motor operation.

Additional protection against moisture may be provided by drain holes on the motor to allow water drainage. Drain holes option is provided on request only and it is necessary to specify in the order the mounting to properly position the holes on the motor.

As standard MGM motors have the stator winding and brake coil treated to work in tropical environments. However a specific tropicalization treatment can be requested, for all motors that have to be installed in high humidity environments.

A rain roof is available on request, for outdoor use or in presence of water jets with vertical mounting and shaft down. The rain roof is positioned above the fan protecting the motor from water and permitting the regular flow of the cooling air. There is no need of a rain roof on BA motors thanks to its particular construction and just a special brake cover for outdoor vertical mounting can be used.

Where brake motors are used in moisture environments or where there are long periods between working cycles, brake disc sticking can occur. To avoid disc sticking it is possible to provide zinc plated or stainless steel brake friction surfaces according to the motor type.

The motor should be provided with protection devices to guard against non ordinary working conditions. The use of protection device on the line is particularly advisable (i.e. varistors) for those motors running at low speed (8, 12, 16 poles) to prevent early wear of windings and of contacts caused by voltage peaks during the switching on.

Operation conditions	Protection type		
	Fuses	Protective circuit breakers	Thermal protective device on the windings
Excess currents 200% In	no protection	excellent protection	excellent protection
Heavy starts, reversing operation	no protection	partial protection	excellent protection
Stalling	partial protection	partial protection	partial protection
Starting on two phases	no protection	partial protection	excellent protection
Voltage deviations	no protection	excellent protection	excellent protection
Frequency deviations	no protection	excellent protection	excellent protection
Insufficient motor cooling	no protection	no protection	excellent protection

On request MGM is able to supply motors equipped with thermistors PTC or bimetallic N.C. thermal protectors:

Bimetallic Thermal Protectors (N.C.): three bimetallic sensors in series with normally closed contacts, fitted on the windings heads. They control a switch (not provided with the motor) that interrupts the power supply when getting close to dangerous temperature. The nominal voltage and current are 250 V and 2,5 A A.C. respectively while the temperature of intervention is 140 °C. The contact closes again with a temperature reduction of at least 35 °C. The bimetallic thermal protectors leads are connected to a terminal board located in the main terminal box.

Thermistors (PTC): three thermistors in series (conforming to DIN standards 44081 and 44802), fitted on the windings heads. The resistance of the thermistors changes with temperature and when getting close to the nominal intervention temperature the sharp increase of resistance guarantees a precise intervention of the safety devices. The thermistor only senses the temperature so a cut-out device (not provided with the motor) must be added to interrupt the power supply to the motor. The maximum PTC operating voltage is 30 V DC while the intervention temperature is 130 °C on class F motors and 140 °C on class H motors. The PTC leads are connected to a terminal board located in the main terminal box.

Over-voltage protection

Low speed motors: when starting motors having a high number of poles (i.e. 8, 12, 16), voltage peaks can be generated damaging the motor insulation materials and contacts. In these cases it is advisable to install safety over-voltage protection devices. On request MGM provides over-voltage protection devices such as RC04 for motors up to 4 kW and RC10 for motors up to 10 kW. Please note that these devices should not be installed if the motor is controlled by an inverter.

Brake coil: DC brake coil is supplied as standard with a rectifier fitted with a protection device against over-voltage and with a filter against the radio frequency emissions. The AC brake coil doesn't generally need this type of protection devices. In case of a very high start/stop frequency or in case of critical line voltage situation it is recommended the use of RC04 filter in order to limit the electrical interference on the brake.

B5

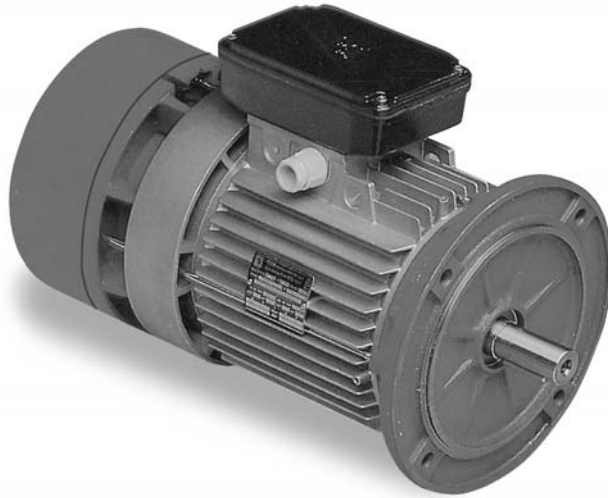

B14

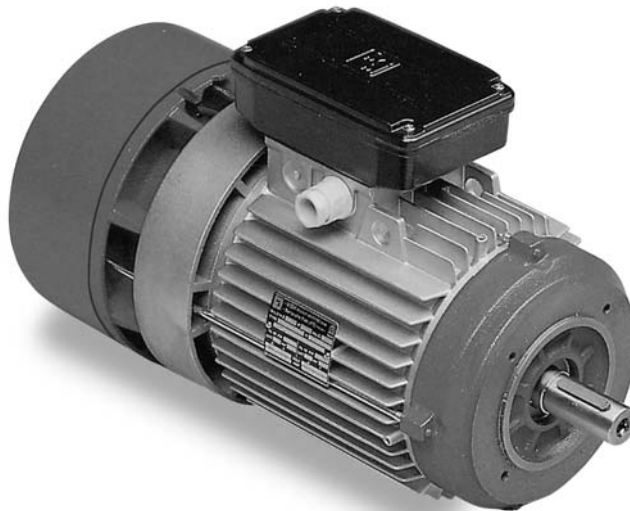

B3

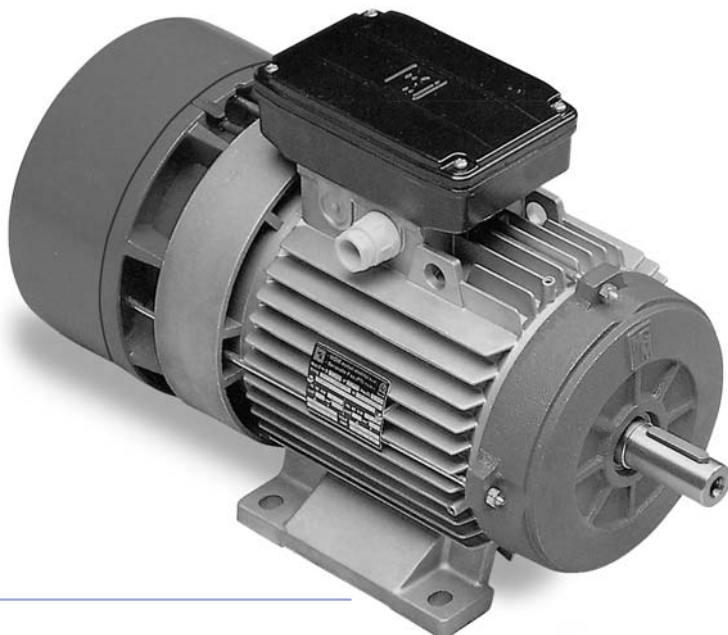

BA Series

BA series consists of three phase, asynchronous brake motors totally enclosed fan cooled. BA series range starts from 71 up to 225 frame size. The motor brakes in case of power supply failure. The braking action is always secured through a very quick and precise stop assuring a safe and prompt stop in case of unintentional power supply failure. The brake torque remains the same in both directions of rotation and the motor brakes without shaft axial sliding. As a standard the brake is AC 3-phase voltage supply with brake leads connected with motor leads in a single terminal board while on request it is possible to supply the brake separately with a second terminal board or to have a DC brake supply with a built-in rectifier fitted inside the terminal box. The rectifier is provided with over-voltage and radio frequencies emission protection devices. BA series motors tolerate high overloading rate and are capable of withstanding overheating so as to guarantee the best reliability even under tough operating conditions. All MGM series motors have been designed to be controlled by inverters. The motor winding insulation is class F, while class H is available on request. Motor construction type is totally enclosed externally cooled and IP54 enclosure (IP55 and IP56 available on request). Motors up to 132 frame size are fitted as standard with a hexagonal hole on the shaft at the non drive end to allow manual rotation, even if power is off. All BA series motors are provided as standard with hand brake release screw.

BA series brake disc has a large lining surface that allows high brake torque, low disc wear and consequently low maintenance cost. The brake torque can be easily adjustable to the desired value just by screwing some nuts. Thanks to its special construction the brake friction surface is self-ventilated on the motor side, permitting a high brake workload and keeping brake time constant. The brake lining material is asbestos free.

BA series motor frame is made of die cast, light metal on motors up to 132 size and the terminal board box, provided with cable glands and plugs, is positioned 180° above the motor support feet. The frame is made of cast iron starting from 160 frame size and the terminal box is located on the right side (drive-end view). Shields and flanges are made of aluminium on motors up to 90 frame size, and of cast iron on motors of 100 frame size and above. As standard feet are frame integrated (they are not simply attached to the frame) on IM B3 mounting (foot mounted) making the motor very sturdy. This feature is very important for those applications where the motor is much stressed during the starts and stops.

The brake friction surfaces are made of cast iron as a standard. The brake moving element and the brake coil have a laminated nucleus to reduce electrical losses and to secure a very quick brake intervention.

BA series main features are its sturdy construction, quick braking action, constant braking time, high number of permissible start/stop cycles also under severe applications, easily adjustable brake torque, low maintenance costs.

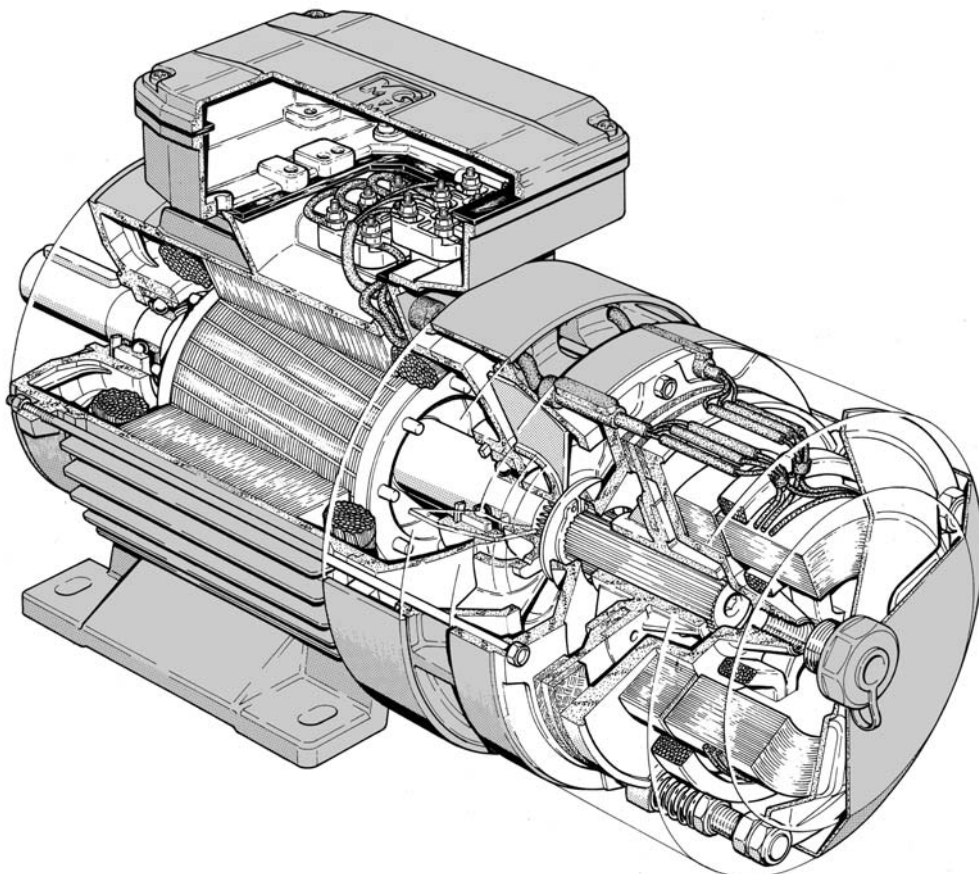

BA series brake group

Air gap adjustment

The air gap (60), that is the distance between the two magnetic cores, the brake coil (25) and brake moving element (24), must stay within the value expressed in the chart below. It is not advisable to exceed the expressed value, in order to avoid vibrations of the brake moving element, very loud noise, the brake coil burning or even the whole brake assembly failure. It is advisable to check periodically the air gap because it increases as a consequence of the brake disc wear. In order to set the air gap to the indicated value, you have to loosen the nuts (21) (22) so to move the brake coil (25) towards the brake moving element (24). Once this operation has been settled be sure to tighten the locknuts.

Frame Size	71-80	90-100	112-132	160-200	225
Air Gap	0.25-0.5	0.3-0.6	0.4-0.8	0.5-1.0	0.6-1.2

Brake torque adjustment

The brake torque is proportional to the springs (18) compression, which can be adjusted tightening or loosening the locknuts (20). The compression of the three springs must be as even as possible. Once the brake is properly supplied, if the brake coil isn't able to attract the brake moving element with a quick stroke and to keep it attracted without any vibrations, check the air gap adjustment and, if this inconvenience still persists, loosen the locknut (20) by two threads and try again until the proper functioning is obtained. It is important to consider that some motors can be equipped with 3 springs and some others with 6. (see page 23). Once this operation is completed, check the brake torque to make sure it is set to the desired value. Never set the brake torque to a higher value than the one indicated on the motor nameplate.

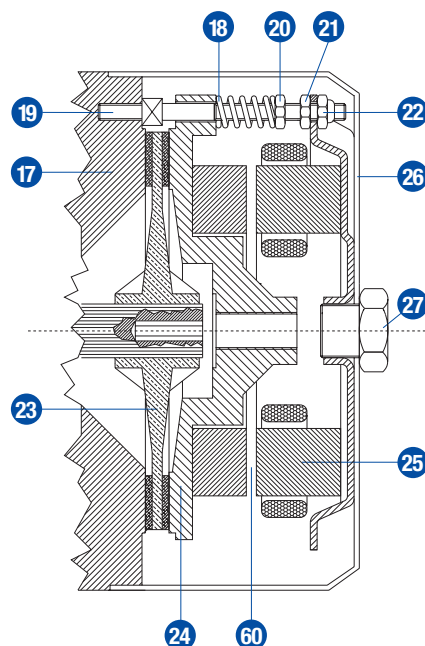

Permissible start frequency under load

The technical data tables provide the ideal no-load start frequency (Z_0). The permissible start frequency when an external load is applied (Z_{load}) can be found with the following formula:

$$Z_{load} = Z_0 \cdot K \cdot R$$

where " Z_0 " is the table-value for the selected motor and " K " and " R " are factors determined by the curves on the side; the factor " K " is related to the ratio of the moment of inertia of the applied load (J_{app}) to that of the motor (J_{mot}) while the factor " R " is related to the ratio of the resisting torque (T_r) to the starting torque (T_s). This calculation gives an approximative indication only. If the required starting frequency is close to Z_{load} , it is advisable to use a motor equipped with thermal protectors. It is necessary to check the maximum energy dissipation limit of the brake group and the maximum motor RPM in those applications where high moment of inertia is involved. On request is available a special brake disc material capable to withstand very high dissipation energy. Please contact MGM technical staff for additional information.

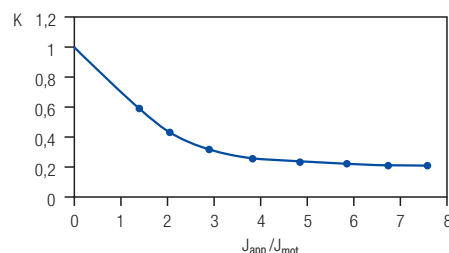
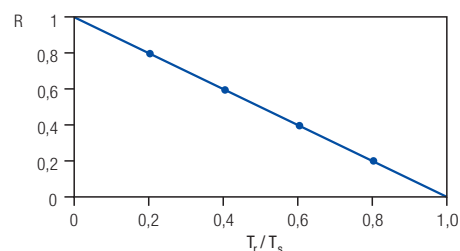

Brake coil wiring diagram

As standard BA series motors are equipped with AC brakes with single terminal board for the brake and the motor while on request it is possible to supply the brake separately. On request DC brakes are available for BA series with the rectifier located inside the terminal box. The rectifier is provided with over-voltage protection devices and with a RFI filter. MGM brake motors equipped with DC brakes can be connected as in diagram A or B according to the needed braking time. MGM motors provided with DC brake coil are connected as in diagram A. The DC brake coil has to be connected according to diagram B to have a reduced brake reaction time.

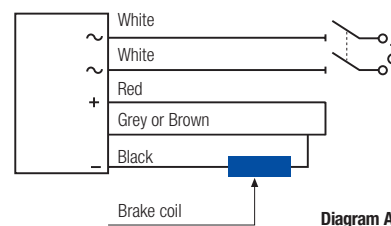

Diagram A

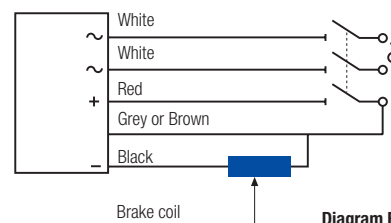

Diagram B

Brake torque and brake spring compression



BA series

BA series motors are provided as standard with a brake torque set to 60 - 70% of the maximum admissible brake torque indicated on the nameplate. On request the motor can come already set to a specific brake torque value different from the standard one. The brake torque is shown in the diagrams here below as a function of the brake assembly spring compression. The shown values refer to BA series motors mounted in horizontal position with an AC brake coil. DC brakes have the same trend as AC brakes even if they have lower brake torque, as shown in the table below.

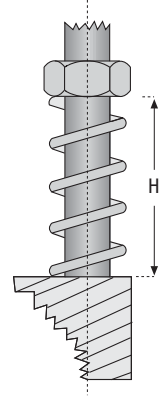

The values shown in the diagrams are only indicative as application conditions, brake lining wear and temperature, can affect the real brake torque. Whenever it is necessary to adjust the braking torque to a specific value it is advisable to directly measure the obtained brake torque after each brake torque adjustment. Consider that the motor mounting position influences remarkably the effective braking torque when low brake torque values are involved. Please contact MGM for further information.

Frame size	71	80	90	100	112	132	160	180	200	225
Max AC Brake Torque (Nm):	14	18	38	50	80	150	190	300	300	400
Max DC Brake Torque (Nm):	9	15	30	42	60	120	155	180	180	240

BA 71

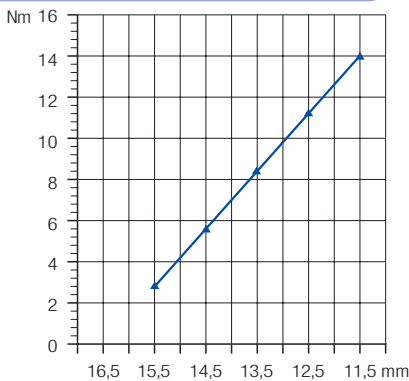

BA 80

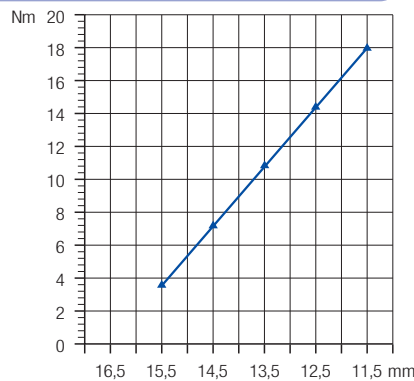

BA 90

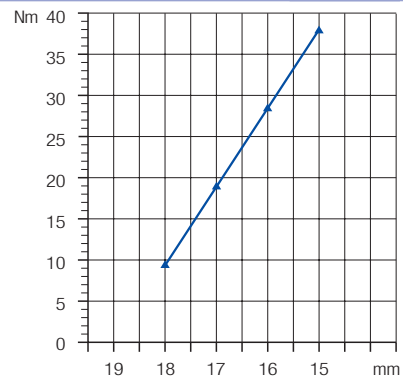

BA 100

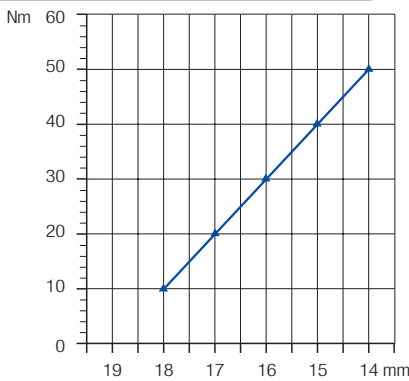

BA 112

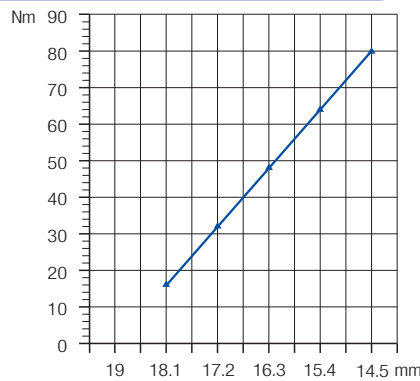

BA 132

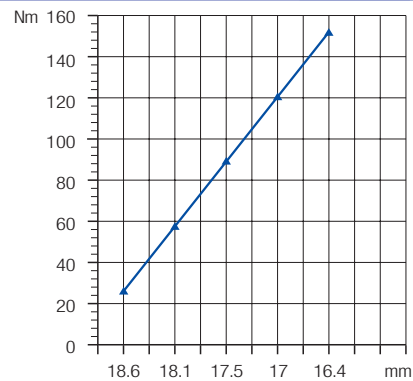

BA 160

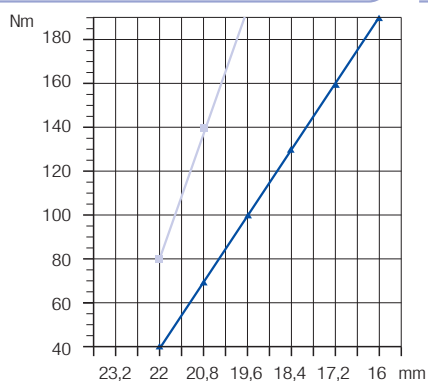

BA 180-200

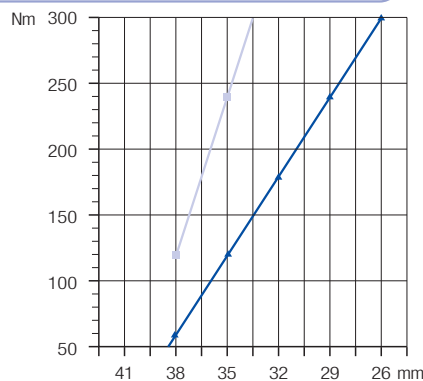

BA 225

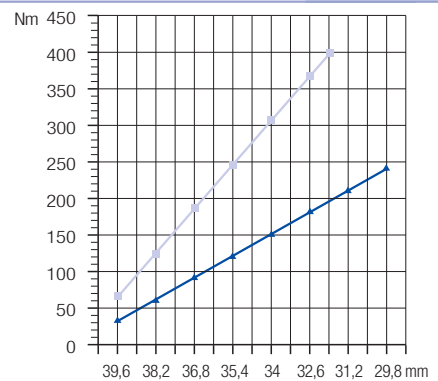

Light blue line: 6 springs brake group
Blue line: 3 springs brake group
Consider that DC brake groups always have 3 springs and 155 Nm max. brake torque.

Light blue line: 6 springs brake group
Blue line: 3 springs brake group
Consider that DC brake groups always have 3 springs and 180 Nm max. brake torque.

Light blue line: 6 springs brake group
Blue line: 3 springs brake group
Consider that DC brake groups always have 3 springs and 240 Nm max. brake torque.

Technical Data Single Speed Motor – Single Winding

Motor type	Power (kW)	RPM	In (A) 400 V	Power factor Cos φ	Ts/Tn	Is/In	AC brake In (mA)	DC brake In (mA)	Z ₀ (starts/hour)	Moment of inertia Jx 10 ⁻⁴ Kg ^m ²	Max Brake torque (Nm)	A-Sound pressure dB(A)	Weight (Kg)
2 poles													3000 r.p.m.
BA 71 A2	0.37	2810	0.90	0.78	2.6	4.5	90	110	6000	4.88	14	59	9.5
BA 71 B2	0.55	2810	1.40	0.78	2.6	4.5	90	110	6000	5.48	14	59	10.5
BA 71 C2 *	0.75	2810	1.8	0.80	2.5	4.5	90	110	5000	6.15	14	59	11.0
BA 80 A2	0.75	2800	1.7	0.86	3.1	5.3	140	150	6000	11.64	18	65	14.5
BA 80 B2	1.1	2800	2.4	0.86	3.1	5.3	140	150	6000	12.96	18	65	15.5
BA 90 SA2	1.5	2850	3.2	0.86	3.0	6.9	300	150	4500	18.95	38	72	20.0
BA 90 LA2	2.2	2840	4.5	0.86	3.0	6.9	300	150	4500	21.84	38	72	22.5
BA 100 LA2	3.0	2860	6.2	0.84	3.2	8.1	300	150	2800	39.82	50	74	30.0
BA 112 MB2	4.0	2880	8.1	0.84	2.5	7.4	280	470	1700	68.96	80	75	44
BA 112 MC2*	5.5	2880	11.4	0.85	2.5	7.4	280	470	1400	85.00	80	75	48
BA 132 SA2	5.5	2890	10.8	0.86	2.8	7.4	580	680	480	192.0	150	75	71
BA 132 SB2	7.5	2890	14.6	0.85	2.8	7.4	580	680	480	231.0	150	75	77
BA 132 MA2 *	9.2	2890	17.9	0.85	2.8	7.4	580	680	420	270.0	150	75	83
BA 132 MB2 *	11.0	2890	21.4	0.85	2.8	7.4	580	680	400	308.0	150	75	90
BA 160 MA2	11.0	2920	19.5	0.94	3.0	8.6	1390	860	350	537.0	190	77	160
BA 160 MB2	15.0	2930	26.3	0.93	3.1	8.8	1390	860	350	537.0	190	77	160
BA 160 LA2	18.5	2930	32.4	0.93	3.1	8.8	1390	860	350	616.0	190	77	171
BA 180 LA2	22.0	2950	36.7	0.95	2.7	9.0	950	1100	120	1150.0	300	78	243
BA 200 LA2	30.0	2940	52.0	0.94	2.8	9.0	950	1100	90	1160.0	300	79	274
BA 200 LB2	37.0	2940	64.1	0.93	2.8	9.0	950	1100	90	1290.0	300	79	289
4 poles													1500 r.p.m.
BA 71 A4	0.25	1400	0.8	0.65	2.5	3.7	90	110	20000	7.20	14	45	9.5
BA 71 B4	0.37	1400	1.10	0.68	2.7	3.9	90	110	19000	8.10	14	45	10.5
BA 71 C4 *	0.55	1360	1.65	0.70	2.4	3.7	90	110	18000	9.43	14	45	11.5
BA 71 D4 *	0.65	1350	2.00	0.69	2.1	3.7	90	110	16000	9.92	14	45	12.0
BA 80 A4	0.55	1400	1.70	0.69	2.1	4.0	140	150	10000	14.97	18	47	14.0
BA 80 B4	0.75	1400	2.20	0.67	2.5	4.3	140	150	10000	17.19	18	47	15.0
BA 80 C4 *	0.9	1390	2.60	0.67	2.8	4.5	140	150	10000	18.30	18	47	16.0
BA 90 SA4	1.1	1400	2.7	0.77	2.3	4.6	300	150	15000	26.15	38	55	20.0
BA 90 LA4	1.5	1400	3.6	0.75	2.7	4.8	300	150	12000	30.53	38	55	22.5
BA 90 LB4 *	1.85	1400	4.3	0.77	2.7	5.8	300	150	9000	34.57	38	55	24.0
BA 90 LC4 *	2.2	1390	5.4	0.75	2.7	5.0	300	150	7000	34.57	38	55	24.0
BA 100 LA4	2.2	1410	5.0	0.78	2.5	5.4	300	150	8000	51.14	50	57	32
BA 100 LB4	3.0	1410	6.5	0.80	2.8	6.4	300	150	7000	60.07	50	57	36
BA 112 MB4	4.0	1415	8.1	0.84	2.6	6.4	280	470	4000	125.7	80	61	45
BA 112 MC4*	5.5	1420	11.5	0.83	2.8	6.9	280	470	3500	145.0	80	61	50
BA 132 SB4	5.5	1430	11.3	0.82	2.4	6.0	580	680	1200	277.0	150	62	78
BA 132 MA4	7.5	1435	14.8	0.84	2.4	6.0	580	680	950	352.0	150	62	87
BA 132 MB4 *	9.2	1445	18.3	0.85	2.5	6.3	580	680	900	432.0	150	62	100
BA 132 MBX4 *	11.0	1440	21.7	0.86	2.5	6.0	580	680	800	432.0	150	62	100
BA 160 MA4	9.2	1460	18.6	0.84	3.0	7.0	1390	860	850	604.0	190	63	148
BA 160 MB4	11.0	1460	21.2	0.85	2.9	7.0	1390	860	850	683.0	190	63	154
BA 160 LA4	15.0	1460	28.5	0.87	2.7	7.0	1390	860	850	858.0	190	63	171
BA 180 LA4	18.5	1460	33.7	0.89	2.9	8.0	950	1100	540	1740.0	300	64	243.0
BA 180 LB4	22.0	1460	41.8	0.85	2.5	7.6	950	1100	540	1740.0	300	64	243.0
BA 200 LB4	30.0	1455	56.5	0.87	2.5	7.4	950	1100	300	1980.0	300	66	274.0
BA 225 S4	37.0	1475	68.1	0.85	2.5	7.9	1350	1500	300	4470.0	400	68	392.0
BA 225 M4	45.0	1475	82.6	0.85	2.5	7.9	1350	1500	300	5140.0	400	68	440.0

* Non Standard Power

Technical Data Single Speed Motor – Single Winding

Motor type	Power (kW)	RPM	In (A) 400 V	Power factor Cos φ	Ts/Tn	Is/In	AC brake In (mA)	DC brake In (mA)	Z ₀ (starts/hour)	Moment of inertia Jx 10 ⁻⁴ Kgm ²	Max Brake torque (Nm)	A-Sound pressure dB(A)	Weight (Kg)
6 poles												1000 r.p.m.	
BA 71 A6	0.18	875	0.60	0.71	2.0	2.6	90	110	28000	10.08	14	45	10.5
BA 71 B6	0.25	900	0.80	0.71	2.0	2.8	90	110	28000	11.54	14	45	11.0
BA 80 A6	0.37	910	1.25	0.67	2.6	3.4	140	150	18000	23.40	18	47	14.5
BA 80 B6	0.55	900	1.8	0.68	2.2	2.8	140	150	18000	27.21	18	47	15.5
BA 90 SA6	0.75	910	2.3	0.68	2.1	3.5	300	150	18000	35.93	38	54	19.5
BA 90 LA6	1.1	910	3.2	0.68	2.2	3.6	300	150	15000	46.08	38	54	22.0
BA 90 LB6*	1.3	910	3.5	0.68	2.5	4.0	300	150	12000	53.00	38	54	24.0
BA 100 LA6	1.5	930	3.9	0.71	2.3	4.3	300	150	11000	87.40	50	56	33.0
BA 100 LB6 *	1.85	920	5.0	0.68	2.6	4.5	300	150	8500	99.19	50	56	35.0
BA 112 MB6	2.2	945	5.2	0.79	2.0	5.3	280	470	6500	168.3	80	58	45
BA 132 SB6	3.0	960	7.2	0.72	2.5	6.5	580	680	1800	346.0	150	58	78
BA 132 MA6	4.0	960	9.5	0.72	2.3	6.5	580	680	1500	401.0	150	58	83
BA 132 MB6	5.5	960	12.3	0.75	2.3	6.5	580	680	1200	508.0	150	58	94
BA 160 MB6	7.5	965	15.9	0.79	2.2	7.1	1390	860	1200	943.0	190	59	156
BA 160 LA6 *	9.2	970	18.3	0.81	2.2	7.1	1390	860	1100	1240.0	190	59	174
BA 160 LB6	11.0	970	22.7	0.80	2.5	7.5	1390	860	950	1240.0	190	59	174
BA 180 LB6	15.0	970	29.4	0.84	2.3	7.8	950	1100	600	2070.0	300	60	243
BA 200 LA6	18.5	970	38.1	0.82	2.2	8.0	950	1100	350	2360.0	300	61	289
BA 200 LB6	22.0	965	43.5	0.85	2.2	8.0	950	1100	350	2360.0	300	61	289
BA 225 M6	30.0	985	58.7	0.82	2.0	7.0	1350	1500	350	7470.0	400	63	440
8 poles												750 r.p.m.	
BA 71 A8	0.08	660	0.60	0.53	2.0	2.0	90	110	30000	7.20	14	43	10.0
BA 71 B8	0.11	660	0.80	0.55	2.0	2.0	90	110	30000	8.10	14	43	10.5
BA 80 A8	0.18	675	0.95	0.59	2.0	2.2	140	150	30000	23.40	18	45	14.5
BA 80 B8	0.25	675	1.25	0.62	2.0	2.2	140	150	30000	27.21	18	45	15.5
BA 90 SA8	0.37	680	1.50	0.60	2.1	2.9	300	150	20000	35.93	38	46	20.0
BA 90 LA8	0.55	690	2.20	0.56	2.1	2.8	300	150	17000	46.08	38	46	22.5
BA 90 LB8*	0.65	690	2.70	0.56	2.1	2.8	300	150	14000	53.00	38	46	24.0
BA 100 LA8	0.75	700	2.75	0.58	2.1	3.0	300	150	14000	87.40	50	49	33.0
BA 100 LB8	1.1	700	4.1	0.59	2.5	4.0	300	150	9400	99.19	50	49	35.0
BA 112 MB8	1.5	705	4.9	0.60	2.0	4.5	280	470	7200	168.3	80	52	45
BA 132 SB8	2.2	700	5.2	0.75	2.1	4.7	580	680	2100	325.0	150	55	73
BA 132 MB8	3.0	700	7.1	0.75	2.1	4.7	580	680	2100	413.0	150	55	80
BA 160 MA8	4.0	725	9.6	0.72	2.3	6.5	1390	860	1800	1030.0	190	58	156
BA 160 MB8	5.5	725	13.6	0.70	2.3	6.1	1390	860	1800	1030.0	190	58	156
BA 160 LA8	7.5	725	18.6	0.70	2.3	6.1	1390	860	1800	1360.0	190	58	174
BA 180 LB8	11.0	730	25.9	0.72	2.0	5.9	950	1100	800	2460.0	300	59	243
BA 200 LA8	15.0	730	32.8	0.77	1.9	6.1	950	1100	500	2880.0	300	60	243

* Non Standard Power

1. Motor characteristic values reported in the tables refer to continuous duty (S1), 50 Hz frequency, ambient temperature max. 40 °C, altitude up to 1000 m. above sea level operating condition.

2. DC brake is provided on request only on BA series motors. Brake current consumption values refer to a rated voltage of 3-phase 400V for AC

brakes and single-phase 230V for DC brakes.

3. The table shows the sound pressure noise level, measured at one metre range from the motor according to the Acurve (ISO 1680). The shown noise levels refer to motor no-load operating condition and should be regarded with a tolerance of ± 3dB.

4. Max brake torque and Z₀ values refer to AC brake. Go to pag. 23 for DC max brake torque values.

5. The rated torque T_n (Nm) for motors can be calculated as follow: $T_n \text{ (Nm)} = \frac{9,55 \times P_n \text{ (W)}}{\text{RPM}}$

Technical Data Two Speed Motor – Single Winding

Motor type	Power (kW)	RPM	In (A) 400 V	Power factor Cos φ	Ts/Tn	Is/In	AC brake In (mA)	DC brake In (mA)	Z ₀ (starts/hour)	Moment of inertia Jx 10 ⁻⁴ Kg ^m ²	Max Brake torque (Nm)	A-Sound pressure dB(A)	Weight (Kg)
2 / 4 poles													3000 / 1500 r.p.m.
BAD 71 A2/4	0.25 0.18	2820 1415	0.75 0.70	0.73 0.66	2.2 2.4	3.8 3.1	90	110	8500 18000	7.20	14	59 45	10.0
BAD 71 B2/4	0.37 0.25	2820 1415	1.00 0.85	0.77 0.63	2.3 2.8	4.7 4.2	90	110	7000 16000	8.10	14	59 45	11.0
BAD 80 A2/4	0.65 0.45	2790 1400	1.80 1.35	0.81 0.72	2.0 2.1	4.1 4.0	140	150	3000 10000	14.97	18	65 47	14.5
BAD 80 B2/4	0.88 0.62	2800 1390	2.2 1.7	0.80 0.74	2.0 2.2	4.9 4.5	140	150	3000 10000	17.19	18	65 47	15.5
BAD 90 SB2/4	1.3 0.9	2800 1420	3.2 2.3	0.85 0.73	2.3 2.5	5.2 5.0	300	150	3000 9500	26.15	38	72 55	20
BAD 90 LA2/4	1.8 1.2	2800 1420	4.4 3.1	0.83 0.71	2.6 3.0	5.6 6.0	300	150	2500 9000	30.53	38	72 55	23
BAD 90 LB2/4	2.2 1.5	2860 1430	5.4 3.8	0.82 0.73	2.5 3.0	5.9 6.0	300	150	2500 8500	34.57	38	72 55	24
BAD 100 LA2/4	2.2 1.5	2875 1425	5.0 3.8	0.85 0.81	2.3 2.5	6.0 5.6	300	150	1800 6500	51.14	50	74 57	32
BAD 100 LB2/4	3.1 2.3	2875 1425	6.7 5.2	0.85 0.82	2.3 2.4	7.0 6.5	300	150	1700 6000	60.07	50	74 57	36
BAD 112 MB2/4	4.5 3.3	2880 1400	9.2 6.9	0.88 0.86	2.4 2.8	7.0 6.5	280	470	900 3800	125.7	80	75 61	45
BAD 132 SB2/4	5.0 4.5	2940 1450	10.9 9.3	0.81 0.84	2.8 2.6	8.0 7.5	580	680	400 1000	277.0	150	75 62	78
BAD 132 MA2/4	6.0 5.0	2940 1450	11.7 10.0	0.88 0.85	2.6 2.5	8.0 7.5	580	680	400 900	352.0	150	75 62	87
BAD 132 MB2/4	7.5 6.0	2940 1450	16.0 12.2	0.82 0.83	2.4 2.5	8.0 7.5	580	680	400 900	352.0	150	75 62	87
BAD 160 MA2/4	9.5 8.0	2870 1420	20.0 16.6	0.89 0.85	2.8 2.6	7.5 6.0	1390	860	300 800	607.0	190	77 63	154
BAD 160 MB2/4	11.0 9.0	2870 1420	23.3 18.7	0.88 0.85	2.8 2.6	6.8 6.0	1390	860	300 800	683.0	190	77 63	154
BAD 160 LA2/4	13.0 11.0	2890 1420	26.1 21.2	0.91 0.87	2.8 2.6	7.0 6.3	1390	860	250 750	858.0	190	77 63	171
BAD 180 LA2/4	17.0 14.0	2900 1440	33.0 26.8	0.89 0.86	2.9 2.7	8.0 6.5	950	1100	100 500	1740.0	300	78 64	243
BAD 180 LB2/4	20.5 17.0	2900 1430	41.5 33.3	0.89 0.86	2.9 2.7	8.0 6.5	950	1100	100 500	1740.0	300	78 64	243
BAD 200 LB2/4	24.0 20.0	2910 1435	49.0 41.0	0.86 0.82	2.5 2.4	8.0 6.5	950	1100	70 250	1980.0	300	79 66	274

Technical Data Two Speed Motor – Single Winding

Motor type	Power (kW)	RPM	In (A) 400 V	Power factor Cos φ	Ts/Tn	Is/In	AC brake In (mA)	DC brake In (mA)	Z ₀ (starts/hour)	Moment of inertia Jx 10 ⁻⁴ Kgm ²	Max Brake torque (Nm)	A-Sound pressure dB(A)	Weight (Kg)
4 / 8 poles										1500 / 750 r.p.m.			
BAD 71 A4/8	0.13 0.07	1385 700	0.35 0.45	0.82 0.60	1.6 1.8	3.0 2.0	90	110	12000 30000	10.08	14	45 43	10.5
BAD 71 B4/8	0.18 0.09	1370 685	0.50 0.60	0.83 0.59	1.8 2.0	3.2 2.0	90	110	11000 30000	11.54	14	45 43	11.0
BAD 71 C4/8	0.22 0.12	1370 685	0.60 0.75	0.83 0.59	1.6 1.8	3.0 2.0	90	110	10000 28000	12.35	14	45 43	12.0
BAD 80 A4/8	0.25 0.18	1405 675	0.70 0.90	0.86 0.65	2.2 2.0	4.1 2.4	140	150	9000 22000	23.40	18	47 45	14.5
BAD 80 B4/8	0.37 0.25	1405 675	0.85 1.15	0.86 0.65	2.2 2.0	4.1 2.4	140	150	9000 22000	27.21	18	47 45	15.5
BAD 90 SA4/8	0.75 0.37	1350 695	1.70 1.80	0.85 0.53	1.8 2.3	3.9 2.7	300	150	10000 15000	35.93	38	55 46	20
BAD 90 LB4/8	1.1 0.6	1390 695	2.7 3.0	0.82 0.53	2.0 2.5	4.5 2.7	300	150	8500 13000	52.62	38	55 46	24
BAD 100 LB4/8	1.6 0.9	1395 700	3.6 3.5	0.87 0.58	2.0 2.2	5.0 3.5	300	150	4100 8500	99.19	50	57 49	35
BAD 112 MB4/8	2.2 1.2	1400 720	4.8 4.6	0.86 0.57	2.5 3.1	5.5 4.1	280	470	3800 8000	168.3	80	61 52	45
BAD 132 SB4/8	3.0 2.0	1440 720	6.6 5.8	0.85 0.64	2.2 2.5	6.0 5.0	580	680	1000 2000	325.0	150	62 55	73
BAD 132 MA4/8	4.0 2.7	1440 720	8.8 7.8	0.85 0.64	2.2 2.5	6.0 5.0	580	680	1000 2000	413.0	150	62 55	80
BAD 132 MB4/8	6.0 4.0	1440 720	13.0 11.6	0.85 0.64	2.2 2.5	6.0 5.0	580	680	1000 2000	611.0	150	62 55	118
BAD 160 MB4/8	6.5 4.5	1470 730	15.1 13.3	0.80 0.62	2.6 2.4	8.0 6.5	1390	860	800 1450	1030.0	190	63 58	156
BAD 160 LA4/8	9.5 6.0	1470 730	21.5 17.6	0.82 0.62	2.6 2.4	8.0 6.5	1390	860	750 1400	1360.0	190	63 58	174
BAD 180 LA4/8	11.0 8.0	1470 730	22.0 19.2	0.85 0.70	2.8 2.4	7.5 7.0	950	1100	450 750	2460.0	300	64 59	243
BAD 180 LB4/8	14.0 9.0	1465 730	27.1 22.3	0.87 0.68	2.7 2.5	7.5 7.0	950	1100	400 700	2460.0	300	64 59	243
BAD 200 LA4/8	18.0 11.0	1430 710	36.3 27.2	0.88 0.71	2.8 2.6	7.5 8.0	950	1100	70 250	2880.0	300	66 60	293
BAD 200 LB4/8	21.0 13.0	1425 710	41.6 31.7	0.88 0.70	2.6 2.4	7.0 6.5	950	1100	70 250	2880.0	300	66 60	293

1. Motor characteristic values reported in the tables refer to continuous duty (S1), 50 Hz frequency, ambient temperature max. 40 °C, altitude up to 1000 m. above sea level operating condition.

2. DC brake is provided on request only on BA series motors. Brake current consumption values refer to a rated voltage of 3-phase 400V for AC

brakes and single-phase 230V for DC brakes.

3. The table shows the sound pressure noise level, measured at one metre range from the motor according to the Acurve (ISO 1680). The shown noise levels refer to motor no-load operating condition and should be regarded with a tolerance of ± 3dB.

4. Max brake torque and Z₀ values refer to AC brake. Go to pag. 23 for DC max brake torque values.

5. The rated torque T_n (Nm) for motors can be calculated as follow: $T_n \text{ (Nm)} = \frac{9,55 \times P_n \text{ (W)}}{\text{RPM}}$

Technical Data Two Speed Motor – Two Windings

Motor type	Power (kW)	RPM	In (A) 400 V	Power factor Cos φ	Ts/Tn	Is/In	AC brake In (mA)	DC brake In (mA)	Z ₀ (starts/hour)	Moment of inertia Jx 10 ⁻⁴ Kg ^m ²	Max Brake torque (Nm)	A-Sound pressure dB(A)	Weight (Kg)
2 / 6 poles											3000 / 1000 r.p.m.		
BADA 71 B2/6	0.25 0.08	2880 940	0.85 0.60	0.74 0.64	2.6 2.2	4.3 2.0	90	110	3600 15000	8.10	14	59 45	6.5
BADA 71 C2/6	0.35 0.10	2880 940	1.05 0.60	0.75 0.59	2.6 2.2	5.0 2.3	90	110	3000 12000	9.43	14	59 45	7.5
BADA 80 A2/6	0.37 0.12	2885 945	1.35 0.80	0.67 0.57	2.6 1.9	5.0 2.5	140	150	2000 15000	14.97	18	65 47	9.0
BADA 80 B2/6	0.55 0.18	2885 945	1.75 1.05	0.67 0.57	2.6 1.9	5.0 2.5	140	150	2000 15000	17.19	18	65 47	10.0
BADA 90 SA2/6	0.9 0.3	2875 950	2.10 1.15	0.86 0.65	2.5 2.2	5.0 2.5	300	150	1800 15000	26.15	38	72 54	11.5
BADA 90 LA2/6	1.2 0.4	2875 950	2.80 1.55	0.86 0.65	2.5 2.2	5.0 2.5	300	150	1800 1350	30.53	38	72 54	14.0
BADA 90 LB2/6	1.4 0.5	2890 940	3.2 1.8	0.86 0.55	2.7 2.5	5.0 3.0	300	150	1800 12000	34.57	38	72 54	15.5
BADA 100 LA2/6	1.6 0.6	2810 900	3.7 1.9	0.85 0.68	2.6 2.3	5.4 3.4	300	150	1800 15000	51.14	50	74 56	19
BADA 100 LB2/6	2.2 0.8	2800 910	4.8 2.5	0.90 0.67	2.6 2.3	5.4 3.4	300	150	1000 15000	60.07	50	74 56	23
BADA 112 MB2/6	3.0 1.0	2870 950	6.4 3.2	0.86 0.61	3.0 3.2	7.0 4.5	280	470	1100 8600	125.7	80	75 58	32
BADA 132 SB2/6	4.0 1.3	2880 940	8.9 3.7	0.85 0.69	3.0 2.8	7.0 4.5	580	680	350 1700	277.0	150	75 58	78
BADA 132 MA2/6	5.5 1.8	2870 940	11.5 5.1	0.88 0.69	3.0 2.8	7.5 4.5	280	680	350 1400	352.0	150	75 58	87
BADA 132 MB2/6	7.0 2.2	2870 940	14.9 6.3	0.88 0.69	3.0 2.8	7.5 4.5	280	680	350 1100	432.0	150	75 58	98
BADA 160 MB2/6	8.0 2.5	2890 950	15.9 6.9	0.92 0.74	3.0 2.0	8.0 4.3	1390	860	250 1000	683.0	190	77 59	154
BADA 160 LA2/6	11.0 3.6	2890 950	21.4 9.3	0.92 0.74	3.0 2.0	8.0 4.3	1390	860	250 900	858.0	190	77 59	171
BADA 180 LB2/6	16.0 6.5	2910 960	30.3 16.0	0.93 0.72	3.0 2.4	8.0 5.0	950	1100	100 250	1740.0	300	78 60	243

Technical Data Two Speed Motor – Two Windings

Motor type	Power (kW)	RPM	In (A) 400 V	Power factor Cos φ	Ts/Tn	Is/In	AC brake In (mA)	DC brake In (mA)	Z ₀ (starts/hour)	Moment of inertia Jx 10 ⁻⁴ Kgm ²	Max Brake torque (Nm)	A-Sound pressure dB(A)	Weight (Kg)
2 / 8 poles											3000 / 750 r.p.m.		
BADA 71 B2/8	0.25 0.06	2900 700	0.85 0.55	0.69 0.54	2.8 1.8	4.0 1.5	90	110	3600 25000	9.10	14	59 43	11.0
BADA 71 C2/8	0.35 0.07	2900 700	1.05 75.00	0.70 0.52	2.5 2.2	4.3 1.6	90	110	3000 22000	9.43	14	65 43	12.0
BADA 80 A2/8	0.37 0.09	2885 690	1.35 0.70	0.67 0.54	2.3 1.8	5.0 1.7	140	150	2000 20000	14.97	18	65 45	14.5
BADA 80 B2/8	0.55 0.12	2885 690	1.75 0.90	0.67 0.54	2.3 2.0	5.0 1.7	140	150	2000 20000	17.19	18	72 45	15.5
BADA 90 SB2/8	0.75 0.18	2800 610	1.90 1.05	0.77 0.65	3.0 2.1	5.1 1.9	300	150	1800 18000	26.15	38	72 46	22.5
BADA 90 LA2/8	1.10 0.25	2800 640	2.70 1.45	0.81 0.58	3.0 2.1	5.1 1.9	300	150	1800 17000	30.53	38	72 46	23.0
BADA 90 LB2/8	1.3 0.3	2820 640	3.10 1.75	0.81 0.58	3.2 2.4	5.7 2.0	300	150	1800 16000	34.57	38	72 46	24.0
BADA 100 LA2/8	1.6 0.4	2810 660	3.7 2.0	0.85 0.58	2.7 2.0	5.3 2.2	300	150	1800 16000	51.14	50	74 49	32
BADA 100 LB2/8	2.2 0.5	2800 660	4.8 2.5	0.90 0.59	2.8 2.3	5.7 2.3	300	150	1000 10500	60.07	50	74 49	36
BADA 112 MB2/8	3.0 0.8	2860 690	6.3 3.5	0.87 0.63	3.3 2.6	7.5 3.2	280	470	1100 9000	125.7	80	75 52	45
BADA 132 SB2/8	4.0 1.1	2880 680	8.9 4.0	0.85 0.60	3.0 1.9	7.0 3.3	580	680	430 1800	277.0	150	75 55	78
BADA 132 MA2/8	5.5 1.5	2870 680	11.5 5.6	0.88 0.59	3.0 2.0	7.5 3.0	580	680	400 1800	352.0	150	75 55	87
BADA 132 MB2/8	7.0 1.8	2870 680	14.9 7.3	0.88 0.59	3.0 2.0	7.5 3.0	580	680	400 1800	432.0	150	75 55	98
BADA 160 MB2/8	8.0 2.2	2880 705	16.7 7.6	0.91 0.65	3.0 1.9	8.0 3.3	1390	860	300 1500	683.0	190	77 58	154
BADA 160 LA2/8	11.0 3.0	2880 710	21.5 10.2	0.92 0.65	3.0 1.9	8.0 3.3	1390	860	300 1500	858.0	190	77 58	171
BADA 180 LB2/8	16.0 4.0	2915 715	30.0 11.5	0.93 0.66	3.0 1.9	8.0 3.3	950	1100	100 300	1740.0	300	79 59	243
BADA 200 LB2/8	18.5 4.5	2915 715	35.0 13.5	0.93 0.66	3.0 1.9	8.0 3.3	950	1100	100 300	2030.0	300	79 59	255

1. Motor characteristic values reported in the tables refer to continuous duty (S1), 50 Hz frequency, ambient temperature max. 40 °C, altitude up to 1000 m. above sea level operating condition.

2. DC brake is provided on request only on BA series motors. Brake current consumption values refer to a rated voltage of 3-phase 400V for AC

brakes and single-phase 230V for DC brakes.

3. The table shows the sound pressure noise level, measured at one metre range from the motor according to the Acurve (ISO 1680). The shown noise levels refer to motor no-load operating condition and should be regarded with a tolerance of ± 3dB.

4. Max brake torque and Z₀ values refer to AC brake. Go to pag. 23 for DC max brake torque values.

5. The rated torque T_n (Nm) for motors can be calculated as follow: $T_n \text{ (Nm)} = \frac{9,55 \times P_n \text{ (W)}}{\text{RPM}}$

Technical Data Two Speed Motor – Two Windings

Motor type	Power (kW)	RPM	In (A) 400 V	Power factor Cos φ	Ts/Tn	Is/In	AC brake In (mA)	DC brake In (mA)	Z ₀ (starts/hour)	Moment of inertia Jx 10 ⁻⁴ Kgm ²	Max Brake torque (Nm)	A-Sound pressure dB(A)	Weight (Kg)
4 / 6 poles												1500 / 1000 r.p.m.	
BADA 71 C4/6	0.18	1415	0.60	0.76	1.9	3.0	90	110	7500	12.35	14	45	12.0
	0.11	930	0.50	0.66	2.0	2.3			15000			45	
BADA 80 A4/6	0.25	1430	0.85	0.79	2.2	4.3	140	150	7000	23.40	18	47	14.5
	0.18	940	0.80	0.71	1.8	3.0			15000			47	
BADA 80 B4/6	0.37	1430	1.05	0.79	2.2	4.3	140	150	7000	27.21	18	47	15.5
	0.25	940	0.95	0.71	1.8	3.0			15000			47	
BADA 90 SA4/6	0.55	1420	1.60	0.78	1.9	3.8	300	150	6000	35.93	38	55	20.0
	0.37	950	1.45	0.62	2.1	3.3			12000			54	
BADA 90 LB4/6	0.75	1420	2.20	0.78	2.0	3.8	300	150	5500	46.08	38	55	23.0
	0.55	950	1.9	0.62	2.1	3.3			10000			54	
BADA 100 LA4/6	1.1	1445	3.0	0.76	2.0	5.3	300	150	2000	86.40	50	57	33.0
	0.8	955	2.4	0.71	2.1	4.4			50000			56	
BADA 100 LB4/6	1.5	1440	3.9	0.75	2.0	5.2	300	150	1800	99.19	50	57	35.0
	1.1	950	3.3	0.68	2.1	4.4			8000			56	
BADA 112 MB4/6	2.0	1385	4.4	0.88	2.6	5.3	280	470	2600	168.3	80	61	45
	1.3	930	3.5	0.75	2.1	4.4			5500			58	
BADA 132 SB4/6	2.2	1440	5.1	0.78	2.9	7.0	580	680	600	346.0	150	62	78
	1.5	950	4.4	0.69	2.6	5.5			1000			58	
BADA 132 MA4/6	3.0	1440	6.4	0.81	2.7	7.0	580	680	600	401.0	150	62	83
	2.2	950	6.0	0.71	2.4	5.0			1000			58	
BADA 132 MB4/6	3.7	1440	8.2	0.78	2.9	7.0	580	680	500	508.0	150	62	94
	2.5	950	7.0	0.69	2.6	5.5			900			58	
BADA 160 MB4/6	5.5	1390	11.1	0.93	2.5	5.8	1390	860	400	943.0	190	63	156
	3.7	940	8.9	0.81	2.3	5.2			700			59	
BADA 160 LB4/6	7.5	1390	15.2	0.93	2.5	6.0	1390	860	400	1240.0	190	63	174
	5.0	940	12.2	0.81	2.3	5.2			700			59	
BADA 180 LB4/6	13.0	1440	24.6	0.91	2.95	7.0	950	1100	350	2070.0	300	64	243
	8.8	950	18.9	0.82	2.00	6.0			850			60	

1. Motor characteristic values reported in the tables refer to continuous duty (S1), 50 Hz frequency, ambient temperature max. 40 °C, altitude up to 1000 m. above sea level operating condition.

2. DC brake is provided on request only on BA series motors. Brake current consumption values refer to a rated voltage of 3-phase 400V for AC

brakes and single-phase 230V for DC brakes.

3. The table shows the sound pressure noise level, measured at one metre range from the motor according to the Acurve (ISO 1680). The shown noise levels refer to motor no-load operating condition and should be regarded with a tolerance of ± 3dB.

4. Max brake torque and Z₀ values refer to AC brake. Go to pag. 23 for DC max brake torque values.

5. The rated torque T_n (Nm) for motors can be calculated as follow: $T_n \text{ (Nm)} = \frac{9,55 \times P_n \text{ (W)}}{\text{RPM}}$

Technical Data Two Speed Motor – Two Windings

Motor type	Power (kW)	RPM	In (A) 400 V	Power factor Cos φ	Ts/Tn	Is/In	AC brake In (mA)	DC brake In (mA)	Z ₀ (starts/hour)	Moment of inertia Jx 10 ⁻⁴ Kgm ²	Max Brake torque (Nm)	A-Sound pressure dB(A)	Weight (Kg)	
4 / 12 poles		S3 40%						1500 / 500 r.p.m.						
BADA 80 A4/12	0.25 0.05	1425 435	0.85 0.60	0.77 0.63	1.8 1.9	3.7 1.6	140	110	7000 24000	23.40	18	47 43	14.5	
BADA 80 B4/12	0.37 0.07	1425 435	1.05 0.75	0.77 0.63	1.8 1.9	3.7 1.6	140	110	7000 24000	27.21	18	47 43	15.5	
BADA 90 SA4/12	0.40 0.13	1360 380	1.25 1.05	0.73 0.59	2.5 2.0	3.5 1.6	300	150	5500 30000	35.93	38	55 44	20.0	
BADA 90 LA4/12	0.55 0.18	1400 400	1.65 1.20	0.76 0.64	2.5 1.8	3.5 1.6	300	150	5500 30000	46.08	38	55 44	23.0	
BADA 90 LB4/12	0.75 0.22	1370 400	2.05 1.60	0.76 0.65	2.5 2.0	3.5 1.6	300	150	5000 28000	52.62	38	55 44	24.0	
BADA 100 LA4/12	0.90 0.25	1440 450	2.3 2.1	0.76 0.50	2.2 1.8	5.3 1.7	300	150	4400 15000	87.40	50	57 47	33.0	
BADA 100 LB4/12	1.10 0.35	1440 450	2.8 2.6	0.76 0.50	2.2 1.8	5.3 1.7	300	150	2100 13000	99.19	50	57 47	35.0	
BADA 112 MB4/12	1.50 0.45	1420 440	3.4 2.4	0.84 0.55	2.2 2.0	6.0 2.2	280	470	2600 15000	168.3	80	61 50	45.0	
BADA 132 SA4/12	2.50 0.80	1440 440	5.4 3.8	0.81 0.53	2.7 1.6	7.0 2.4	580	680	800 2200	346.0	150	62 58	78.0	
BADA 132 MA4/12	3.0 1.0	1440 440	6.4 4.5	0.81 0.53	2.7 1.6	7.0 2.4	580	680	800 2200	401.0	150	62 58	83	
BADA132 MB4/12	4.0 1.3	1440 440	8.5 5.9	0.81 0.55	2.7 1.6	7.0 2.4	580	680	800 2200	508.0	150	62 58	94	
BADA 160 MB4/12	4.8 1.6	1425 455	10.0 7.2	0.89 0.57	2.8 2.0	7.5 3.0	1390	860	600 1700	943.0	190	63 61	156	
BADA 160LB4/12	7.3 2.4	1410 445	15.2 10.1	0.90 0.61	2.8 2.0	7.0 3.0	1390	860	600 1700	1240.0	190	63 61	174	

1. Motor characteristic values reported in the tables refer to continuous duty (S1), 50 Hz frequency, ambient temperature max. 40 °C, altitude up to 1000 m. above sea level operating condition.

2. DC brake is provided on request only on BA series motors. Brake current consumption values refer to a rated voltage of 3-phase 400V for AC

brakes and single-phase 230V for DC brakes.

3. The table shows the sound pressure noise level, measured at one metre range from the motor according to the Acurve (ISO 1680). The shown noise levels refer to motor no-load operating condition and should be regarded with a tolerance of ± 3dB.

4. Max brake torque and Z₀ values refer to AC brake. Go to pag. 23 for DC max brake torque values.

5. The rated torque T_n (Nm) for motors can be calculated as follow: $T_n \text{ (Nm)} = \frac{9,55 \times P_n \text{ (W)}}{\text{RPM}}$

Technical Data Two Speed Motor – Two Windings

Motor type	Power (kW)	RPM	In (A) 400 V	Power factor Cos φ	Ts/Tn	Is/In	AC brake In (mA)	DC brake In (mA)	Z ₀ (starts/hour)	Moment of inertia Jx 10 ⁻⁴ Kg ^m ²	Max Brake torque (Nm)	A-Sound pressure dB(A)	Weight (Kg)
2 / 12 poles		S3 40%										3000 / 500 r.p.m.	
BADA 80 B2/12	0.45 0.07	2840 435	1.35 0.70	0.76 0.63	1.9 1.9	4.9 1.4	140	150	1700 24000	27.21	18	65 43	15.5
BADA 90 SB2/12	0.75 0.11	2800 400	2.10 1.05	0.82 0.61	3.0 2.0	5.2 1.4	300	150	1800 20000	26.15	38	72 44	22.5
BADA 90 LA2/12	1.10 0.15	2800 400	2.80 1.35	0.82 0.63	3.2 2.1	5.4 1.4	300	150	1800 20000	30.53	38	72 44	23
BADA 100 LB2/12	1.85 0.25	2850 410	4.1 2.2	0.87 0.52	3.0 2.2	6.3 1.5	300	150	1100 11000	60.07	50	73 47	36
BADA 112 MB2/12	3.00 0.45	2855 430	6.5 3.2	0.86 0.49	3.0 2.1	6.7 1.8	280	470	1200 10000	125.7	80	73 50	45
BADA 132 SB2/12	4.00 0.65	2880 450	8.9 4.8	0.85 0.56	3.0 1.8	7.0 1.6	580	680	350 2200	277.7	150	73 55	78
BADA 132 MA2/12	5.50 0.90	2870 450	11.5 6.7	0.88 0.56	3.0 1.8	7.5 1.6	580	680	350 2200	352.0	150	73 55	87
BADA 132 MB2/12	7.00 1.10	2870 450	14.9 8.2	0.88 0.56	3.0 1.8	7.5 1.6	580	680	350 2200	432.0	150	73 55	98
BADA 160 MB2/12	8.00 1.30	2890 470	15.9 9.5	0.92 0.42	3.0 2.0	8.0 2.1	1390	860	250 1200	683.0	190	74 58	154
BADA 160 LA2/12	11.00 1.80	2890 470	21.4 12.8	0.92 0.42	3.0 2.0	8.0 2.1	1390	860	250 1200	858.0	190	74 58	171
BADA 180 LB2/12	16.00 2.60	2910 470	30.6 12.2	0.93 0.46	3.0 1.8	8.0 2.0	950	1100	200 1000	1740.0	300	78 59	243

Hoisting motors 4/16 poles

Motor Type	Power(kW)	RPM	In 400 V (A)	Ibrake (mA) AC
Service duty S4 (40% 4 pole – 25% 16 poles)		1500 / 375 r.p.m.		
BAPKDA 132 MA4/16	2.8 / 0.7	1450 / 350	7.3 / 5.1	580
BAPKDA 132 MB4/16	4.0 / 1.1	1450 / 350	10.8 / 7.6	580
BAPKDA 160 MA4/16	5.5 / 1.3	1420 / 335	11.6 / 8.0	1390
BAPKDA 160 MB4/16	7.3 / 1.8	1420 / 330	16.2 / 11.4	1390
BAPKDA 160 LB4/16	10.0 / 2.5	1420 / 330	22.2 / 15.9	1390
BAPKDA 180 LA4/16	13.2 / 3.0	1450 / 350	25.0 / 21.7	950
BAPKDA 200 LB4/16	16.0 / 4.0	1450 / 350	31.5 / 27.4	950
BAPKDA 225 S4/16	19.0 / 4.8	1470 / 360	38.2 / 28.0	1350
BAPKDA 225 M4/16	24.0 / 6.0	1470 / 360	47.3 / 34.7	1350

1. Motor characteristic values reported in the tables refer to continuous duty (S1), 50 Hz frequency, ambient temperature max. 40 °C, altitude up to 1000 m. above sea level operating condition.

2. DC brake is provided on request only on BA series motors. Brake current consumption values refer to a rated voltage of 3-phase 400V for AC

brakes and single-phase 230V for DC brakes.

3. The table shows the sound pressure noise level, measured at one metre range from the motor according to the Acurve (ISO 1680). The shown noise levels refer to motor no-load operating condition and should be regarded with a tolerance of ± 3dB.

4. Max brake torque and Z₀ values refer to AC brake. Go to pag. 23 for DC max brake torque values.

5. The rated torque T_n (Nm) for motors can be calculated as follow: $T_n (Nm) = \frac{9.55 \times P_n (W)}{RPM}$

brake linings wear

Brake linings wear is mainly affected by the environmental conditions in which the motor operates, by the frequency of starts, by the energy dissipated at each stop and by the torque provided by the brake. The lining temperature rises with the braking frequency and with the moment of inertia applied to the shaft. When the lining temperature rises, the lining wear increases and consequently the braking time is longer. BA series motors are designed to have continuous cooling of the braking surfaces so as to reduce brake disc wear to have a shorter braking time.

The life cycle of the brake linings can be roughly expressed by the number of brake interventions and can be approximately calculated as follows:

$$n = W_{tot} / W_b$$

where W_b (J) is the work done during each braking action and W_{tot} (J) is obtained from the table for each type of brake motor. However, it is necessary to check the brake disc wear periodically to replace the brake disc before it is completely worn. If you want to estimate the interval between two successive air gap adjustment in a specific application, note that the brake linings wear is greater than usual during the run-in (a few thousands stops).

On PV series brake motors W_{tot} shown in the table have to be multiplied by 0.5 and the moment of inertia have to be calculated considering the presence of the fly-wheel. The indicative number of AC brake stops N_{intAC} between two successive air gap adjustments on a BA motor is given by the following formula:

$$N_{intAC} = E_{rBA} / W_b$$

while the N_{intDC} for DC brake motors is given by : $N_{intDC} = N_{intAC} \cdot 0.65$

	71	80	90	100	112	132	160	180	200	225
W_{tot} (MJ)	537	705	952	1148	1438	2255	3290	4355	4355	5226
E_{rBA} (MJ)	56	80	95	105	130	200	290	385	385	462

The indicative number of DC brake stops N_{intBM} between two successive air gap adjustments on a BM motor is given by the following formula:

$$N_{intBM} = E_{rBM} / W_b$$

E_{rBM} values are shown at pag. 39 (BM section).

Starting and braking time

Starting current for an asynchronous motor is always much higher than the nominal current. When the starting time is excessively long, there are electromechanical disturbances and higher temperatures on winding, damaging the motor. For information on maximum starting time allowed for each type of motor, please contact MGM. An indicative value for starting time t_s (expressed in seconds) and the angle of rotation φ_s (expressed in radians) can be obtained as follows:

$$t_s = \frac{(J_{mot} + J_{app}) \cdot n}{9.55 (T - T_{load})} \quad \varphi_s = \frac{t_s \cdot n}{19.1}$$

Where J_{app} (Kgm^2) is the moment of inertia referred to the motor shaft, M_{load} (Nm) is the opposing torque to the motor, J_{mot} (Kgm^2) is the moment of inertia of the motor, n (RPM is the rated motor RPM), T is the average starting torque, $T = (0,8 \div 0,9) T_s$ (see the technical data table for J_{mot} , n and T_s of the selected motor).

An indicative braking time t_f (s) can be calculated as follows: $t_f = \frac{J_{tot} \cdot n}{9.55 (T_b \pm T_{load})} + \frac{t_B}{1000}$

Brake electrical reaction time t_B (ms)

Motor Type	AC Brake	DC Brake (Standard)	DC Brake (Quick)
BA 71-80-90	7	80	20
BA 100-112	9	80	30
BA 132-160	12	85	30
BA 180-200	12	90	30
BA 225	14	100	35

Where: J_{tot} total moment of inertia at the motor shaft (Kgm^2)
 n motor RPM (min^{-1})
 T_b brake torque (Nm)
 T_{load} resisting load torque (Nm) with + sign if matches the brake torque, or - sign if opposite.
 t_B brake electrical reaction time (ms)

The reported t_B times are valid only if the motor is connected with the brake. In case the brake is supplied separately, the t_B time has to be cut by 30 – 50%. This calculation gives an approximative indication. Please contact MGM for further information.

BA series 71 – 225 dimensions

Dimension	BA 71	BA 80	BA 90 S	BA 90 L	BA 100 L	BA 112 M	BA 132 S	BA 132 M	BA 160 M	BA 160 L	BA 180 L	BA 200 L	BA 225 S	BA 225 M
A	112	125	140	140	160	190	216	216	254	254	279	318	356	356
B	90	100	100	125	140	140	140	178	210	254	279	305	286	311
C	45	50	56	56	63	70	89	89	108	108	121	133	149	149
D*	14	19	24	24	28	28	38	38	42	42	48	55	60	60
d	M5	M6	M8	M8	M10	M10	M12	M12	M16	M16	M16	M16	M16	M16
E*	30	40	50	50	60	60	80	80	110	110	110	110	140	140
Fa	9.5	11.5	11.5	11.5	14	14	14	14	18	18	18	18	18.5	18.5
Fb	M6	M6	M8	M8	M8	M8	M10	M10						
f	5	6	8	8	8	8	10	10	12	12	14	16	18	18
g	11	15.5	20	20	24	24	33	33	37	37	42.5	49	53	53
H	71	80	90	90	100	112	132	132	160	160	180	200	225	225
h	5	6	7	7	7	7	8	8	8	8	9	10	11	11
I	7	10	10	10	12	12	12	12	14.5	14.5	15	18.5	18	18
K	10.5	14	14	14	16	16	22	22	24	24	24	30	33	33
L	148	162	171	196	217	229								
L1	184	194	207	232	254	262	294	339	373	395	420	446	452	464.5
Ma	130	165	165	165	215	215	265	265	300	300	300	350	400	400
Mb	85	100	115	115	130	130	165	165						
Na	110	130	130	130	180	180	230	230	250	250	250	300	350	350
Nb	70	80	95	95	110	110	130	130						
Oa	3.5	3.5	3.5	3.5	4	4	4	4	5	5	5	5	5	5
Ob	2.5	3	3	3	3.5	3.5	3.5	3.5						
Pa	160	200	200	200	250	250	300	300	350	350	350	400	450	450
Pb	105	120	140	140	160	160	200	200						
Q	344	380	412	436	487	505	606	644	732	776	860	885	977	1002
QBAF/BAPV	368	403	436	460	511	531	634	672	765	809	907	932	1014	1035
R	80	80	98,5	98,5	98,5	98,5								
R1	135	135	170	170	170	170	199	199	268	268	268	268	268	268
S	10	12	12	12	14	14	15	15	15	15	15	15	16	16
V	8	9.5	10.5	10.5	12.5	13.5	16	16	21	21	24	24	30	30
W	105	113	127	127	138	158			165	165	188	188	215	215
W1	121	130	148	148	162	176	215	215	246	246	266	266	321.5	321.5
Y	145	160	180	180	196	218	265	265	324	324	357	357	430	430
Z	75	75	98.5	98.5	98.5	98.5								
Z1	86	86	112	112	112	112	151	151	167	167	167	167	167	167

* 225S-225M 2 poles D=55, E=110

Notes: QBAF is the Q dimension for BAF series

QBAPV is the Q dimension for BAPV series

Cable glands are M 20 on size 71 up to 80

M 25 on size 90 up to 112

M 32 on size 132

PG 29 on size 160 up to 200

M 50 on size 225

B3 (Foot Mounting)

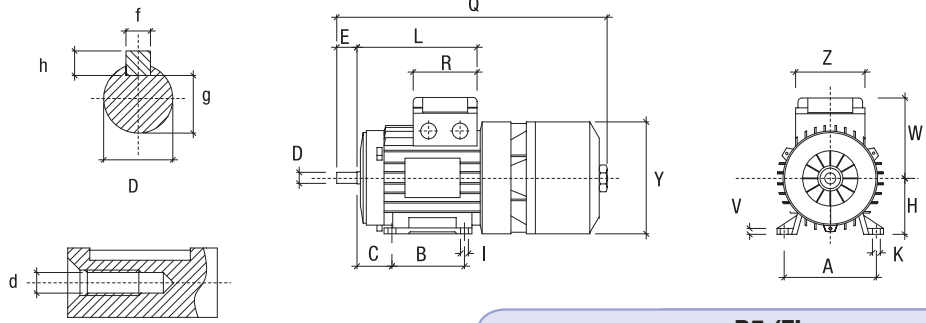

B5 (Flange mounting)

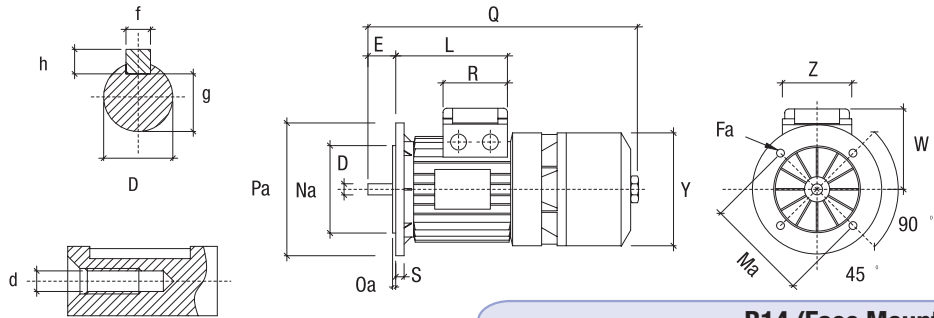

B14 (Face Mounting)

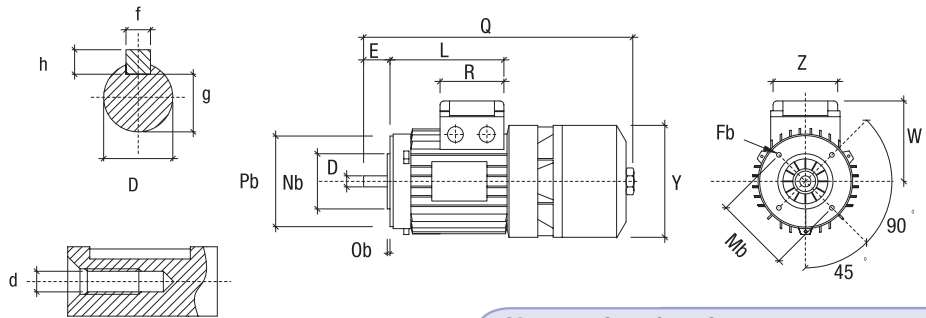

Size 160/180/200/225 B3 (Foot Mounting)

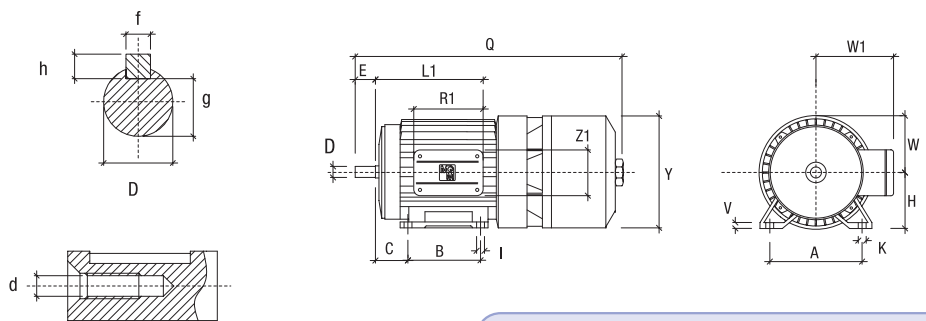

Double Terminal Board Box

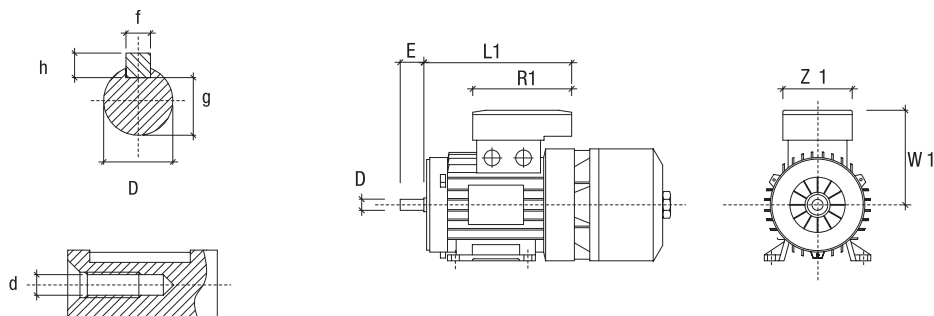

B5

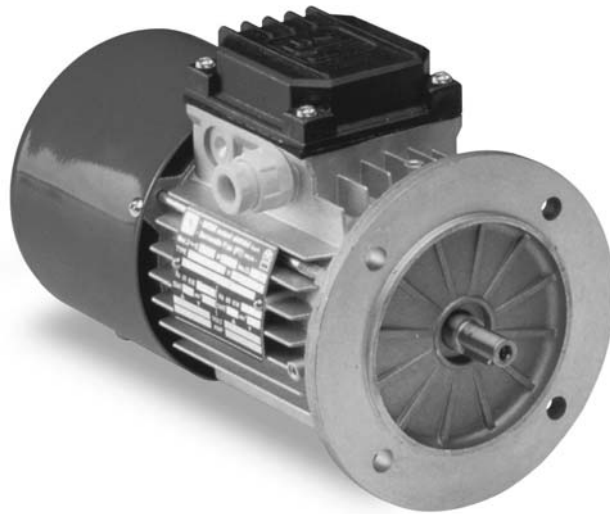

B14

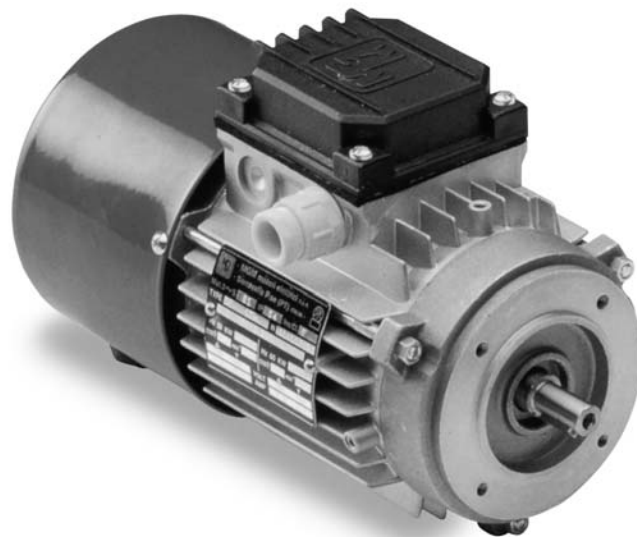

B3

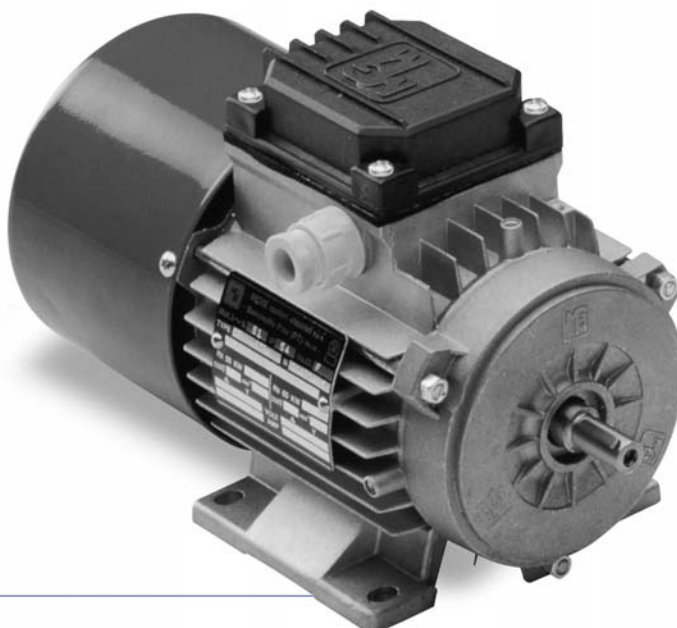

BM series

BM series consists of three phase, asynchronous brake motors totally enclosed fan cooled. BM series range starts from 56 up to 160 frame size. The motor brakes in case of power supply failure. The brake torque remains the same in both directions of rotation and the motor brakes without shaft axial sliding. As standard the brake is DC voltage supply with a built-in rectifier fitted inside the terminal box. The rectifier is provided with over-voltage and radio frequencies emission protection devices. Two different types of rectifier wiring can be chosen according to two different brake intervention time.

BM series is designed in order to have a braking action as quiet as possible. BM series motors tolerate a high overloading rate and are capable to withstand overheating so to guarantee best reliability also under tough operating conditions.

All MGM motors have been designed to be controlled by inverters. The motor winding insulation is class F, while class H is available on request. Motor construction type is totally enclosed externally cooled and IP54 enclosure (IP55 and IP56 available on request).

Motors up to 132 frame size are fitted as standard with a hexagonal hole on the shaft at non drive end to allow manual rotation, even if power is off. On request, BM series motors can be provided with side manual brake release lever. The brake disc lining material is asbestos free and the lining mixture is formulated to have a high friction coefficient and long lasting.

BM series motor frame is made of die cast, light metal on motors up to 132 size and the terminal board box, provided with cable glands and plugs, is positioned 180° above the motor support feet. The frame is made of cast iron starting from 160 frame size and the terminal box is located on the right side (drive-end view). Shields and flanges are made of aluminium on motors up to 90 frame size, and of cast iron on motors of 100 frame size and above. On IM B3 mounting (foot mounted) feet are frame integrated (they are not simply attached to the frame) as standard and it makes the motor very sturdy. This feature is very important for those applications where the motor is much stressed during the starts and stops. BM series main features are the low braking noise, gradual acceleration during the motor start and stop and reduced overall dimensions.

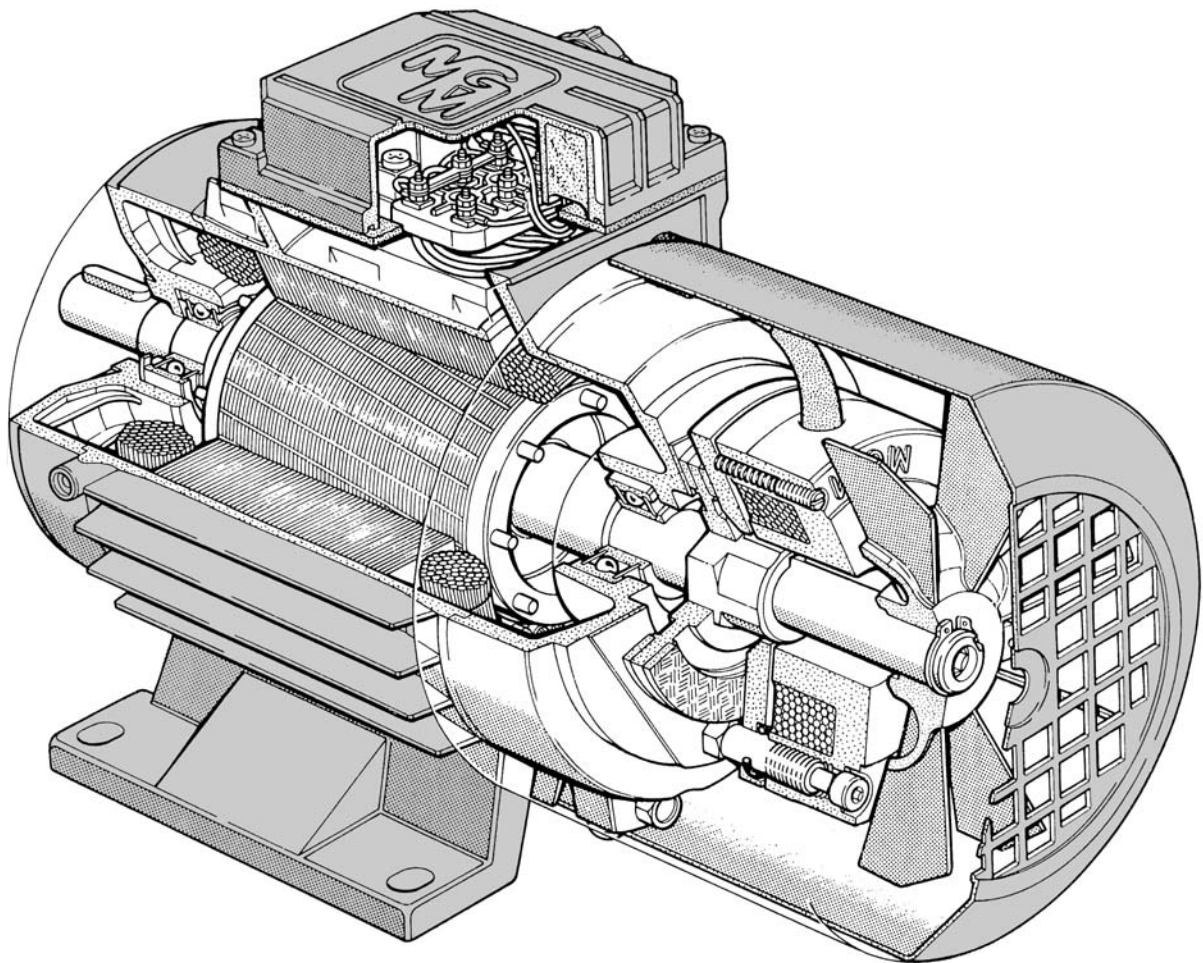

BM series brake group

General description

BM series motors are equipped with DC brake coil. DC brake coil is supplied through a rectifier located in the terminal box (standard voltage supply is 230V 50/60 Hz). The rectifier is provided with over-voltage and radio frequencies emission protection devices. The brake torque remains the same in both directions of rotation and the motor brakes without shaft axial sliding. Brake torque can be set loosening or tightening the adjustable springs (78) where available or removing the central springs or replacing the fixed ones.

Never set the brake torque to a higher value than the one indicated on the motor nameplate.

BM series motors are fitted as a standard with a hexagonal hole on the shaft at non drive end to allow manual rotation. On request BM series motors can be provided with brake release return lever located on the motor side.

Air gap adjustment

The air gap (60), that is the distance between the two magnetic cores, the brake coil (75) and brake moving element (74), must stay within the value expressed in the chart below. It is advisable to check periodically the air gap because it increases as a consequence of the brake disc wear. In order to restore the air gap within the proper value release the connecting screws (77), move the brake coil (75) towards the brake moving element (74) operating on the fixing screws (79). Once this operation has been settled be sure to tighten clockwise the connecting screws (77) so to fasten again the brake coil.

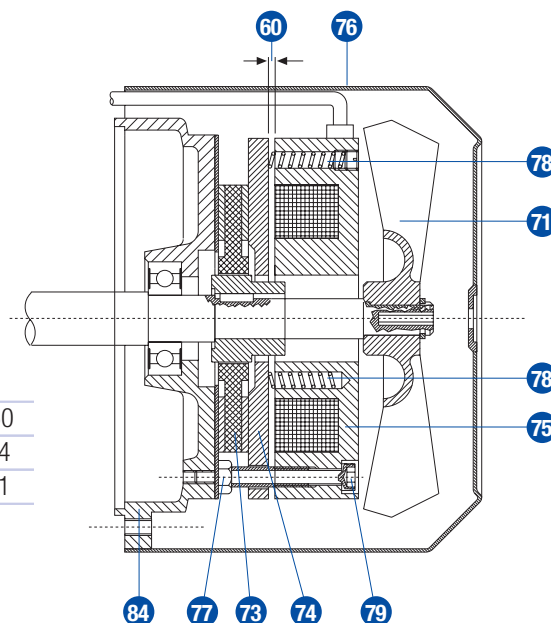

Frame Size	63/71	80	90	100	112	132	160
Min Air Gap[mm]	0,2	0,2	0,3	0,3	0,3	0,4	0,4
Max Air Gap[mm]	0,6	0,7	0,8	0,9	1,0	1,1	1,1

Permissible start frequency with load

The technical data tables provide the ideal no-load start frequency (Z_0). The permissible start frequency when an external load is applied (Z_{load}) can be calculated as follows:

$$Z_{load} = Z_0 \cdot K \cdot R$$

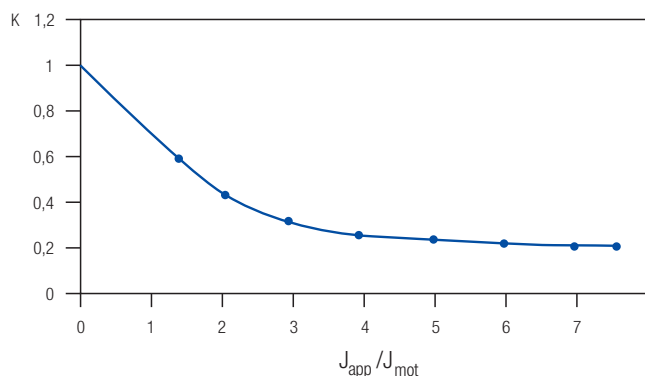
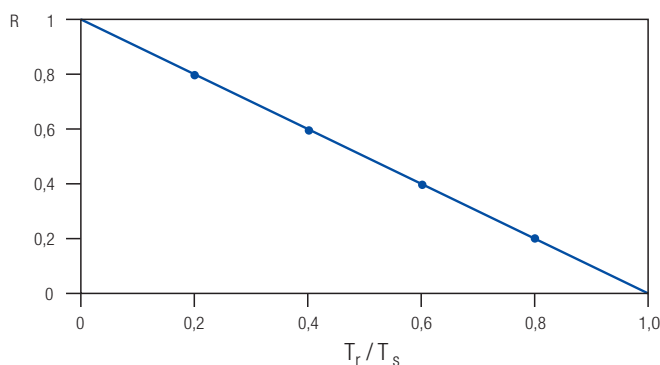

where "Z₀" is the table-value for the selected motor and "K" and "R" are factors determined by the curves on the side; the factor "K" refers to the calculated ratio between the moment of inertia of the applied load (J_{app}) and that of the motor (J_{mot}) while the factor "R" is the calculated ratio between the resisting torque (T_r) and the starting torque (T_s). This calculation gives an approximative indication only. If the required starting frequency is close to Z_{load} , it is advisable to use a motor equipped with thermal protectors. It is necessary to check the maximum energy dissipation limit of the brake group and the maximum motor RPM on those application where high moment of inertia is involved. Please contact MGM technical staff for additional information.

Rectifiers wiring diagram

BM series brake motors can be connect as diagram A or B according to the needed braking time. MGM motors are always provided with DC brake coil connected as diagram A. The DC brake coil has to be connected according to diagram B in order to have a quicker brake action. Here below brake intervention times and brake release time are provided.

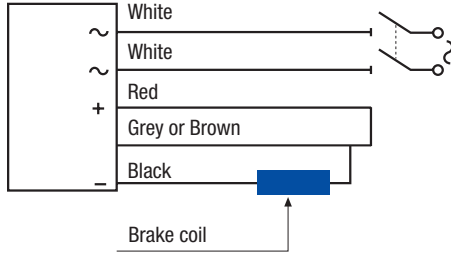

Diagram A

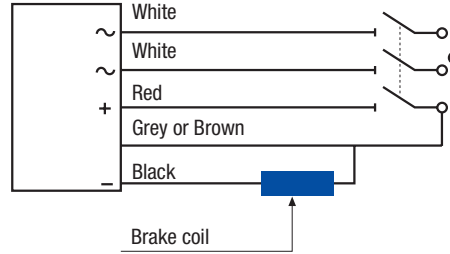
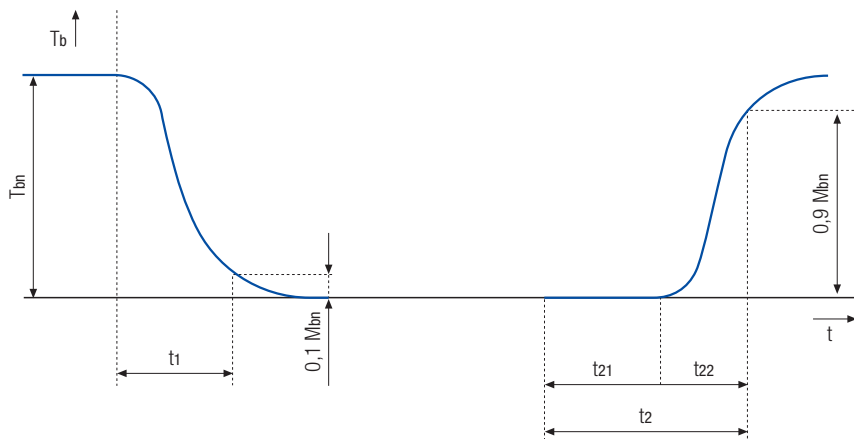

Diagram B

The chart here below describes the trend of the braking torque as a function of time, during the start (on the left) and stop (on the right). The table below also show times for each type of motor and the values of E_r (MJ) to calculate the number of braking actions between two consecutive air gap adjustment. (See page 33).



- T_b Brake Torque
- T_{bn} Nominal Brake Torque
- t_1 Switch-on time
- t_{21} Delay Time
- t_{22} Rise Time
- t_2 Reaction Time

Frame size	t_1 (ms)	t_{21} quick (ms)	t_{22} quick (ms)	t_2 quick (ms)	t_{21} standard (ms)	t_{22} standard (ms)	t_2 standard (ms)	E_{rEM} (MJ)
56	30	10	15	25	35	25	60	7*
63	35	10	15	25	40	30	70	15
71	35	10	15	25	40	30	70	15
80	45	15	30	45	50	45	95	23
90	60	20	40	60	80	60	140	29
100	80	25	50	75	100	75	175	33
112	120	30	60	90	120	90	210	36
132	160	40	80	120	160	120	280	39
160	200	50	100	150	200	150	350	44

*Note: The air gap can't be restored on BM56 motors. The brake disc have to be replaced when the air gap exceed the stated value.

Braking Time

The braking time t_f (s) can be calculated as follows:
$$t_f = \frac{J_{tot} \cdot n}{9.55 (T_b \pm T_{load})} + \frac{t_2}{1000}$$

- Where: J_{tot} total moment of inertia at the motor shaft (Kgm²)
- n motor RPM (min⁻¹)
- T_b brake torque (Nm)
- T_{load} resisting load torque (Nm) with + sign if matches the brake torque, or - sign if opposite
- t_2 brake electrical reaction time (ms)

This calculation gives an approximative indication. Please contact MGM staff for more information.

Technical Data Single Speed Motor – Single Winding

Motor type	Power (kW)	RPM	In (A) 400 V	Power factor Cos φ	Ts/Tn	Is/In	DC brake In (mA)	Z ₀ (starts/hour)	Moment of inertia Jx 10 ⁻⁴ Kg ^m ²	Max Brake torque (Nm)	A-Sound pressure dB(A)	Weight (Kg)
2 Poles 3000 RPM												
BM 56 A2	0.09	2820	0.38	0.60	3.0	3.8	130	10000	1.85	2	58	4.0
BM 56 B2	0.12	2760	0.40	0.69	3.0	3.8	130	10000	1.85	2	58	4.0
BM 63 A2	0.18	2800	0.60	0.71	3.0	3.5	200	9000	1.93	5	59	4.5
BM 63 B2	0.25	2800	0.75	0.76	3.5	5.0	200	7500	1.93	5	59	5.0
BM 63 C2*	0.37	2760	1.00	0.80	2.5	3.8	200	6000	2.30	5	59	5.5
BM 71 A2	0.37	2810	0.90	0.78	2.6	4.5	200	4150	3.35	5	59	7
BM 71 B2	0.55	2810	1.40	0.78	2.6	4.5	200	4150	3.95	5	59	8
BM 71 C2*	0.75	2810	1.80	0.80	2.5	4.5	200	3100	4.62	5	59	9
BM 80 A2	0.75	2800	1.70	0.86	3.1	5.3	160	3100	7.29	10	65	12
BM 80 B2	1.1	2800	2.40	0.86	3.1	5.3	160	3100	8.61	10	65	13
BM 90 SA2	1.5	2850	3.20	0.86	3.0	6.9	190	2550	14.54	20	72	17
BM 90 LA2	2.2	2840	4.50	0.86	3.0	6.9	190	2550	17.43	20	72	19
BM 100 LA2	3.0	2860	6.20	0.84	3.2	8.1	250	1850	33.18	40	74	23
BM 112 MB2	4.0	2880	8.10	0.84	2.5	7.4	470	1100	67.89	60	75	38
BM 112 MC2*	5.5	2880	11.40	0.85	2.5	7.4	470	900	83.70	60	75	40
BM 132 SA2	5.5	2890	10.8	0.86	2.8	7.4	600	350	150.90	100	75	59
BM 132 SB2	7.5	2890	14.6	0.85	2.8	7.4	600	350	189.90	100	75	65
BM 132 MA2*	9.2	2890	17.9	0.85	2.8	7.4	600	300	229.70	100	75	71
BM 132 MB2*	11.0	2890	21.4	0.85	2.8	7.4	600	300	267.70	100	75	78
BM 160 MA2	11.0	2920	19.5	0.94	3.0	8.8	700	250	461.00	150	77	142
BM 160 MB2	15.0	2930	26.3	0.93	3.1	8.8	700	250	461.00	150	77	142
BM 160 LA2	18.5	2930	32.4	0.93	3.1	8.8	700	250	540.00	150	77	153
4 Poles 1500 RPM												
BM 56 A4	0.06	1390	0.40	0.48	3.0	2.2	130	12000	1.85	2	41	4.0
BM 56 B4*	0.09	1320	0.41	0.61	3.0	2.2	130	12000	1.85	2	41	4.0
BM 56 C4	0.12	1320	0.55	0.61	3.0	2.2	130	12000	1.85	2	41	4.0
BM 63 A4	0.12	1330	0.45	0.70	2.0	2.4	200	12000	2.47	5	42	4.5
BM 63 B4	0.18	1350	0.60	0.71	3.0	2.8	200	12000	3.08	5	42	5.0
BM 63 C4*	0.22	1350	0.75	0.66	2.8	3.1	200	12000	3.55	5	42	5.5
BM 63 D4*	0.30	1350	1.05	0.64	2.8	3.0	200	12000	3.83	5	42	6.0
BM 71 A4	0.25	1400	0.80	0.65	2.5	3.7	200	10300	5.67	5	45	7.0
BM 71 B4	0.37	1400	1.10	0.68	2.7	3.9	200	10300	6.57	5	45	8.0
BM 71 C4*	0.55	1360	1.65	0.70	2.4	3.7	200	8150	7.90	5	45	9.0
BM 71 D4*	0.65	1350	2.00	0.69	2.1	3.7	200	8150	8.39	5	45	9.5
BM 80 A4	0.55	1400	1.70	0.69	2.1	4.0	160	8150	10.62	10	47	12.0
BM 80 B4	0.75	1400	2.20	0.67	2.5	4.3	160	7250	12.84	10	47	13.0
BM 80 C4*	0.90	1390	2.60	0.68	2.8	4.5	160	5150	13.95	10	47	14.0
BM 90 SA4	1.10	1400	2.70	0.77	2.3	4.6	190	5150	21.74	20	55	16.5
BM 90 LA4	1.50	1400	3.60	0.75	2.7	4.8	190	4100	26.12	20	55	19.0
BM 90 LB4*	1.85	1400	4.30	0.77	2.7	5.8	190	4100	30.16	20	55	21.5
BM 90 LC4*	2.2	1390	5.40	0.75	2.7	5.0	190	4100	30.16	20	55	21.5
BM 100 LA4	2.2	1410	5.00	0.78	2.5	5.4	250	3300	44.50	40	57	25
BM 100 LB4	3.0	1410	6.50	0.80	2.8	6.4	250	3300	53.43	40	57	29
BM 112 MB4	4.0	1415	8.10	0.84	2.6	6.4	470	1600	133.50	60	61	39
BM 112 MC4*	5.5	1420	11.50	0.83	2.8	6.9	470	1100	155.00	60	61	44
BM 132 SB4	5.5	1430	11.30	0.82	2.4	6.0	600	500	235.90	100	62	66
BM 132 MA4	7.5	1435	14.80	0.84	2.4	6.0	600	400	310.90	100	62	75
BM 132 MB4*	9.2	1445	18.30	0.85	2.5	6.3	600	400	391.30	100	62	88
BM 132 MBX4*	11.0	1440	21.70	0.86	2.5	6.0	600	400	391.30	100	62	88
BM 160 MA4	9.2	1460	18.60	0.84	3.0	7.0	700	370	531.00	150	63	130
BM 160 MB4	11.0	1460	21.20	0.85	2.9	7.0	700	370	607.00	150	63	136
BM 160 LA4	15.0	1460	28.50	0.87	2.7	7.0	700	370	782.00	150	63	153

* Non Standard Power

Technical Data Single Speed Motor – Single Winding



BM series

Motor type	Power (kW)	RPM	In (A) 400 V	Power factor Cos φ	Ts/Tn	Is/In	DC brake In (mA)	Z ₀ (starts/hour)	Moment of inertia Jx 10 ⁻⁴ Kg ^m ²	Max Brake torque (Nm)	A-Sound pressure dB(A)	Weight (Kg)
6 Poles											1000 RPM	
BM 56 B6	0.06	850	0.45	0.71	1.9	1.5	130	12000	1.85	2	41	4.0
BM 63 C6	0.09	890	0.50	0.56	2.4	1.9	200	12000	3.55	5	42	5.5
BM 63 D6	0.12	870	0.60	0.64	2.7	1.9	200	12000	3.83	5	42	6.0
BM 71 A6	0.18	875	0.60	0.71	2.0	2.6	200	11500	8.55	5	45	7.5
BM 71 B6	0.25	900	0.80	0.71	2.0	2.8	200	11500	10.01	5	45	8.0
BM 80 A6	0.37	910	1.25	0.67	2.6	3.4	160	9700	19.05	10	47	12.0
BM 80 B6	0.55	900	1.80	0.68	2.2	2.8	160	9250	22.86	10	47	13.0
BM 90 SA6	0.75	910	2.30	0.68	2.1	3.5	190	7300	31.52	20	54	16.0
BM 90 LA6	1.10	910	3.20	0.68	2.2	3.6	190	5400	41.67	20	54	18.5
BM 90 LB6*	1.30	910	3.50	0.68	2.5	4.0	190	4300	48.10	20	54	20.5
BM 100 LA6	1.50	930	3.90	0.71	2.3	4.3	250	3650	80.76	40	56	26
BM 100 LB6	1.85	920	5.00	0.68	2.6	4.5	250	3200	92.55	40	56	28
BM 112 MB6	2.20	945	5.20	0.79	2.0	5.3	470	2100	200.60	60	58	39
BM 132 SB6	3.00	960	7.20	0.72	2.5	6.5	600	650	304.90	100	58	66
BM 132 MA6	4.00	960	9.50	0.72	2.3	6.5	600	550	360.70	100	58	71
BM 132 MB6	5.50	960	12.30	0.75	2.3	6.5	600	550	467.70	100	58	82
BM 160 MB6	7.50	965	15.90	0.79	2.2	7.1	700	550	867.00	150	59	138
BM 160 LA6*	9.20	970	18.30	0.81	2.2	7.1	700	500	1160.00	150	59	156
BM 160 LB6	11.00	970	22.70	0.80	2.5	7.5	700	440	1160.00	150	59	156
8 Poles											750 RPM	
BM 63 D8	0.07	650	0.45	0.62	2.2	1.55	200	15000	3.83	5	42	6.0
BM 71 A8	0.08	660	0.60	0.53	2.0	2.0	200	8750	5.67	5	43	7.5
BM 71 B8	0.11	660	0.80	0.55	2.0	2.0	200	8750	6.57	5	43	8.0
BM 80 A8	0.18	675	0.95	0.59	2.0	2.2	160	8150	19.05	10	45	12.0
BM 80 B8	0.25	675	1.25	0.62	2.0	2.2	160	7250	22.86	10	45	13.0
BM 90 SA8	0.37	690	1.50	0.60	2.1	2.9	190	7000	31.52	20	46	16.5
BM 90 LA8	0.55	690	2.20	0.56	2.1	2.8	190	5400	41.67	20	46	19
BM 90 LB8*	0.65	690	2.70	0.56	2.1	2.8	190	4400	48.00	20	46	21
BM 100 LA8	0.75	700	2.75	0.58	2.1	3.0	250	3850	80.76	40	49	26
BM 100 LB8	1.1	700	4.10	0.59	2.5	4.0	250	3600	92.55	40	49	28
BM 112 MB8	1.5	705	4.90	0.60	2.0	4.5	470	2500	200.60	60	52	39
BM 132 SB8	2.2	700	5.20	0.75	2.1	4.7	600	700	283.90	100	55	61
BM 132 MB8	3.0	700	7.10	0.75	2.1	4.7	600	700	372.70	100	55	68
BM 160 MA8	4.0	725	9.60	0.72	2.3	6.5	700	630	959.00	150	58	138
BM 160 MB8	5.5	725	13.60	0.70	2.3	6.1	700	630	959.00	150	58	138
BM 160 LA8	7.5	725	18.60	0.70	2.3	6.1	700	630	1280.00	150	58	156

* Non Standard Power

1. Motor characteristic values reported in the tables refer to continuous duty (S1), 50 Hz frequency, ambient temperature max. 40 °C, altitude up to 1000 m. above sea level operating condition.

2. The expressed brake torque is the max admissible one.

Brake current consumption values refer to a rated voltage of 230V AC single-phase.

3. The table shows the sound pressure noise level, measured at one metre range from the motor according to the Acurve (ISO 1680). The shown noise levels refer to motor no-load

operating condition and should be regarded with a tolerance of ± 3dB.

4. The rated torque T_n (Nm) for motors can be calculated as follow: $T_n (Nm) = \frac{9,55 \times P_n (W)}{RPM}$

Technical Data Two Speed Motor – Single Winding

Motor type	Power (kW)	RPM	In (A) 400 V	Power factor Cos φ	Ts/Tn	Is/In	DC brake In (mA)	Z ₀ (starts/hour)	Moment of inertia Jx 10 ⁻⁴ Kg ^m ²	Max Brake torque (Nm)	A-Sound pressure dB(A)	Weight (Kg)
2 / 4 Poles											3000 / 1500 RPM	
BMD 63 B2/4	0.22 0.15	2800 1400	0.80 0.75	0.68 0.56	3.00 3.00	4.5 3.2	200	5500 7000	3.08	5	55 42	5.0
BMD 63 C2/4	0.26 0.17	2800 1400	0.90 0.85	0.76 0.61	2.90 3.00	4.2 3.3	200	5000 6000	3.55	5	55 42	5.5
BMD 71 A2/4	0.25 0.18	2820 1415	0.75 0.70	0.73 0.66	2.2 2.4	3.8 3.1	200	2850 5500	5.67	5	59 45	7.0
BMD 71 B2/4	0.37 0.25	2820 1415	1.00 0.85	0.77 0.63	2.3 2.8	4.7 4.2	200	2850 5500	6.47	5	59 45	8.0
BMD 80 A2/4	0.65 0.45	2790 1400	1.80 1.35	0.81 0.72	2.0 2.1	4.1 4.0	160	2500 4400	10.62	10	65 47	12.0
BMD 80 B2/4	0.88 0.62	2800 1390	2.20 1.70	0.80 0.74	2.5 2.2	4.9 4.5	160	2500 4400	12.84	10	65 47	13.0
BMD 90 SB2/4	1.3 0.9	2800 1420	3.20 2.30	0.85 0.73	2.3 2.5	5.2 5.0	190	1650 2900	21.74	20	72 55	16.5
BMD 90 LA2/4	1.8 1.2	2800 1420	4.40 3.10	0.83 0.71	2.6 3.0	5.6 6.0	190	1200 2100	26.12	20	72 55	19.5
BMD 90 LB2/4	2.2 1.5	2860 1430	5.40 3.80	0.82 0.73	2.5 3.0	5.9 6.0	190	1050 1750	30.16	20	72 55	20.5
BMD 100 LA2/4	2.2 1.5	2875 1425	5.00 3.80	0.85 0.81	2.3 2.5	6.0 5.6	250	1050 1750	44.5	40	74 57	25
BMD 100 LB2/4	3.1 2.3	2875 1425	6.70 5.20	0.85 0.82	2.3 2.4	7.0 6.5	250	850 1400	53.4	40	74 57	29
BMD 112 MB2/4	4.5 3.3	2880 1400	9.20 6.90	0.88 0.86	2.4 2.6	7.0 6.5	470	350 1400	133.5	60	75 61	39
BMD 132 SB2/4	5.0 4.5	2940 1450	10.90 9.30	0.81 0.84	2.8 2.6	8.0 7.5	600	150 350	235.9	100	75 62	66
BMD 132 MA2/4	6.0 5.0	2940 1450	11.70 10.00	0.88 0.85	2.1 2.5	8.0 7.5	600	150 320	310.9	100	75 62	75
BMD 132 MB2/4	7.5 6.0	2940 1450	16.00 12.20	0.82 0.83	2.4 2.5	8.0 7.5	600	150 320	310.9	100	75 62	75
BMD 160 MA2/4	9.5 8.0	2870 1420	20.00 16.60	0.89 0.85	2.8 2.6	7.5 6.0	700	120 320	607.0	150	77 63	136
BMD 160 MB2/4	11.0 9.0	2870 1420	23.30 18.70	0.88 0.85	2.8 2.6	6.8 6.0	700	120 320	607.0	150	77 63	136
BMD 160 LA2/4	13.0 11.0	2890 1420	26.10 21.20	0.91 0.87	2.8 2.6	7.0 6.3	700	100 300	782.0	150	77 63	153
4 / 8 Poles											1500 / 750 RPM	
BMD 71 A4/8	0.13 0.07	1385 700	0.35 0.45	0.82 0.60	1.6 1.8	3.0 2.0	200	4300 7300	8.55	5	45 43	8.0
BMD 71 B4/8	0.18 0.09	1370 685	0.50 0.60	0.83 0.59	1.8 2.0	3.2 2.0	200	4100 6900	10.01	5	45 43	8.5
BMD 71 C4/8	0.22 0.12	1370 685	0.60 0.75	0.83 0.59	1.6 1.8	3.0 2.0	200	3850 6700	10.82	5	45 43	9.0
BMD 80 A4/8	0.25 0.18	1405 675	0.70 0.90	0.86 0.65	2.2 2.0	4.1 2.4	160	4300 7300	19.05	10	47 45	12.0
BMD 80 B4/8	0.37 0.25	1405 675	0.85 1.15	0.86 0.65	2.2 2.0	4.1 2.4	160	3250 5500	22.86	10	47 45	13.0
BMD 90 SA4/8	0.75 0.37	1350 695	1.70 1.80	0.85 0.53	1.8 2.3	3.9 2.7	190	3200 5500	31.52	20	55 46	16.5
BMD 90 LB4/8	1.1 0.6	1390 695	2.70 3.00	0.82 0.53	2.0 2.5	4.5 2.7	190	2900 4900	48.21	20	55 46	20.5
BMD 100 LB4/8	1.6 0.9	1395 700	3.60 3.50	0.87 0.58	2.0 2.2	5.0 3.5	250	1850 3100	92.55	40	57 49	28
BMD 112 MB4/8	2.2 1.2	1400 720	4.80 4.60	0.86 0.57	2.5 3.1	5.5 4.1	470	1400 3000	200.60	60	61 52	39
BMD 132 SB4/8	3.0 2.0	1440 720	6.60 5.80	0.85 0.64	2.2 2.5	6.0 5.0	600	380 750	283.90	100	62 55	61
BMD 132 MA4/8	4.0 2.7	1440 720	8.80 7.80	0.85 0.64	2.2 2.5	6.0 5.0	600	380 750	372.70	100	62 55	68
BMD 132 MB4/8	6.0 4.0	1440 720	13.00 11.60	0.85 0.64	2.2 2.5	6.0 5.0	600	380 750	533.70	100	62 55	106
BMD 160 MB4/8	6.5 4.5	1470 730	15.10 13.30	0.80 0.62	2.6 2.5	2.4 5.0	700	320 580	959.00	150	63 58	138
BMD 160 LA4/8	9.5 6.0	1470 730	21.50 17.60	0.82 0.62	2.6 2.4	8.0 6.5	700	300 560	1280.00	150	63 58	156

Technical Data Two Speed Motor – Two Windings

Motor type	Power (kW)	RPM	In (A) 400 V	Power factor Cos φ	Ts/Tn	Is/In	DC brake In (mA)	Z ₀ (starts/hour)	Moment of inertia Jx 10 ⁻⁴ Kg·m ²	Max Brake torque (Nm)	A-Sound pressure dB(A)	Weight (Kg)
2 / 6 Poles												
3000/1000 RPM												
BMDA 71 B2/6	0.25 0.08	2880 940	0.85 0.60	0.74 0.64	2.6 2.2	4.3 2.0	200	7300 14400	6.57	5	59 45	8.5
BMDA 71 C2/6	0.35 0.10	2880 940	1.05 0.60	0.75 0.59	2.6 2.2	5.0 2.3	200	6850 13500	7.90	5	59 45	9.5
BMDA 80 A2/6	0.37 0.12	2885 945	1.35 0.80	0.67 0.57	2.6 1.9	5.0 2.5	160	4150 11000	10.62	10	65 47	12.0
BMDA 80 B2/6	0.55 0.18	2885 945	1.75 1.05	0.67 0.57	2.6 1.9	5.0 2.5	160	3100 9200	12.84	10	65 47	13.0
BMDA 90 SA2/6	0.9 0.3	2875 950	2.10 1.15	0.86 0.65	2.5 2.2	5.0 2.5	190	2300 6850	21.74	20	72 54	16.5
BMDA 90 LA2/6	1.2 0.4	2875 950	2.80 1.55	0.86 0.65	2.5 2.2	5.0 2.5	190	2000 5450	26.12	20	72 54	19.5
BMDA 90 LB2/6	1.4 0.5	2890 940	3.20 1.80	0.86 0.55	2.7 2.5	5.0 3.0	190	1650 4100	30.16	20	72 54	20.5
BMDA 100 LA2/6	1.6 0.6	2810 900	3.70 1.90	0.85 0.68	2.6 2.3	5.4 3.4	250	1650 4100	44.50	40	74 56	25
BMDA 100 LB2/6	2.2 0.8	2800 910	4.80 2.50	0.90 0.67	2.6 2.3	5.4 3.4	250	1550 3650	53.43	40	74 56	28
BMDA 112 MB2/6	3.0 1.0	2870 950	6.40 3.20	0.86 0.61	3.0 3.2	7.0 4.5	470	450 3250	133.50	60	75 58	26
BMDA 132 SB2/6	4.0 1.3	2880 940	8.90 3.70	0.85 0.69	3.0 2.8	7.0 4.5	600	150 650	235.90	100	75 58	66
BMDA 132 MA2/6	5.5 1.8	2870 940	11.50 5.10	0.88 0.69	3.0 2.8	7.5 4.5	600	150 550	310.90	100	75 58	75
BMDA 132 MB2/6	7.0 2.2	2870 940	14.90 6.30	0.88 0.69	3.0 2.8	7.5 4.5	600	150 450	391.30	100	75 58	76
BMDA 160 MB2/6	8.0 2.5	2890 950	15.90 6.90	0.92 0.74	3.0 2.0	8.0 4.3	700	100 400	607.00	150	77 59	136
BMDA 160 LA2/6	11.0 3.6	2890 950	21.40 9.30	0.92 0.74	3.0 2.0	8.0 4.3	700	100 360	782.00	150	77 59	153
2 / 8 Poles												
300/750 RPM												
BMDA 63 C2/8	0.18 0.04	2700 630	0.60 0.40	0.80 0.58	2.2 1.9	5.0 2.1	200	2500 1800	3.55	5	55 42	5.5
BMDA 71 B2/8	0.25 0.06	2900 700	0.85 0.55	0.69 0.54	2.5 1.8	4.0 1.5	200	7300 17500	6.57	5	59 43	8.5
BMDA 71 C2/8	0.35 0.07	2900 700	1.05 0.75	0.70 0.52	2.5 2.2	4.3 1.6	200	6150 14400	7.90	5	59 43	9.5
BMDA 80 A2/8	0.37 0.09	2885 690	1.35 0.70	0.67 0.54	2.3 1.8	5.0 1.7	160	4100 13500	10.62	10	65 45	12.0
BMDA 80 B2/8	0.55 0.12	2885 690	1.75 0.90	0.67 0.54	2.3 2.0	5.0 1.7	160	3100 12750	12.84	10	65 45	13.0
BMDA 90 SB2/8	0.75 0.18	2800 610	1.90 1.05	0.77 0.65	3.0 2.1	5.1 1.9	190	1950 9250	21.74	20	72 46	16.5
BMDA 90 LA2/8	1.10 0.25	2800 640	2.70 1.45	0.80 0.64	3.0 2.1	5.1 1.9	190	1750 7750	26.12	20	72 46	19.5
BMDA 90 LB2/8	1.3 0.3	2820 640	3.10 1.75	0.81 0.58	3.2 2.4	5.7 2.0	190	1650 7250	30.16	20	72 46	20.5
BMDA 100 LA2/8	1.6 0.4	2810 660	3.70 2.00	0.85 0.58	2.7 2.0	5.3 2.2	250	1650 5750	44.50	40	73 49	25
BMDA 100 LB2/8	2.2 0.5	2800 660	4.80 2.50	0.90 0.59	2.8 2.3	5.7 2.3	250	1550 5100	53.43	40	73 49	29
BMDA 112 MB2/8	3.0 0.8	2860 690	6.30 3.50	0.87 0.63	3.3 2.6	7.5 3.2	470	650 4200	133.50	60	75 61	39
BMDA 132 SB2/8	4.0 1.1	2880 680	8.90 4.00	0.85 0.60	3.0 1.9	7.0 3.3	600	260 1100	235.90	100	75 62	66
BMDA 132 MA2/8	5.5 1.5	2870 680	11.50 5.60	0.88 0.59	3.0 2.0	7.5 3.0	600	250 1100	310.90	100	75 62	75
BMDA 132MB2/8	7.0 1.8	2870 680	14.90 7.30	0.88 0.59	3.0 2.0	7.5 3.0	600	250 1100	391.30	100	75 62	86
BMDA 160 MB2/8	8.0 2.2	2880 705	16.70 7.60	0.91 0.65	3.0 1.9	8.0 3.3	700	180 900	607.00	150	77 58	136
BMDA 160 LA2/8	11.0 3.0	2880 710	21.50 10.20	0.92 0.95	3.0 1.9	8.0 3.3	700	180 900	782.00	150	77 58	153

1. Motor characteristic values reported in the tables refer to continuous duty (S1), 50 Hz frequency, ambient temperature max. 40 °C, altitude up to 1000 m. above sea level operating condition.

2. The expressed brake torque is the max admissible one.

Brake current consumption values refer to a rated voltage of 230V AC single-phase.

3. The table shows the sound pressure noise level, measured at one metre range from the motor according to the Acurve (ISO 1680). The shown noise levels refer to motor no-load

operating condition and should be regarded with a tolerance of ± 3dB.

4. The rated torque Tn (Nm) for motors can be calculated as follow: $T_n \text{ (Nm)} = 9,55 \times P_n \text{ (W)}$
RPM

Technical Data Two Speed Motor – Two Windings

Motor type	Power (kW)	RPM	In (A) 400 V	Power factor Cos φ	Ts/Tn	Is/In	DC brake In (mA)	Z ₀ (starts/hour)	Moment of inertia Jx 10 ⁻⁴ Kg·m ²	Max Brake torque (Nm)	A-Sound pressure dB(A)	Weight (Kg)
4 / 6 Poles											1500 / 1000 RPM	
BMDA 71 C4/6	0.18 0.11	1415 930	0.60 0.50	0.76 0.66	1.9 2.0	3.0 2.3	200	14500 19500	10.82	5	45 45	8.5
BMDA 80 A4/6	0.25 0.18	1430 930	0.85 0.80	0.79 0.71	2.2 1.8	4.3 3.0	160	8250 11500	19.05	10	47 47	12.0
BMDA 80 B4/6	0.37 0.25	1430 930	1.05 0.95	0.79 0.71	2.2 1.8	4.3 3.0	160	1300 10300	22.86	10	47 47	13.0
BMDA 90 SA4/6	0.55 0.37	1420 950	1.60 1.45	0.78 0.62	1.9 2.1	3.8 3.3	190	6900 9750	31.52	20	55 54	16.5
BMDA 90 LB4/6	0.75 0.55	1420 950	2.20 1.90	0.78 0.62	2.0 2.1	3.8 3.3	190	5700 8200	41.67	20	55 54	19.5
BMDA 100 LA4/6	1.1 0.8	1445 955	3.00 2.40	0.76 0.71	2.0 2.1	5.3 4.4	250	3100 4400	80.76	40	57 56	26
BMDA 100 LB4/6	1.5 1.1	1440 950	3.90 3.30	0.75 0.68	2.0 2.1	5.2 4.4	250	3000 4200	92.55	40	57 56	28
BMDA 112 MB4/6	2.0 1.3	1385 930	4.40 3.50	0.88 0.75	2.6 2.1	5.3 4.4	470	1550 3300	200.60	60	75 61	39
BMDA 132 SB4/6	2.2 1.5	1440 950	5.10 4.40	0.78 0.69	2.9 2.6	7.0 5.5	600	360 600	304.90	100	75 62	66
BMDA 132 MA4/6	3.0 2.2	1440 950	6.40 6.00	0.81 0.71	2.7 2.4	7.0 5.0	600	360 600	360.70	100	75 62	71
BMDA 132 MB4/6	3.7 2.5	1440 950	8.20 7.00	0.78 0.69	2.9 2.6	7.0 5.5	600	300 550	467.70	100	75 62	82
BMDA 160 MB4/6	5.5 3.7	1390 940	11.10 8.90	0.93 0.81	2.5 2.3	5.8 5.2	700	240 420	867.00	150	63 59	138
BMDA 160 LB4/6	7.5 5.0	1390 940	15.20 12.20	0.93 0.81	2.5 2.3	6.0 5.2	700	240 420	1160.00	150	63 59	156
4 / 12 Poles											S3 40% 1500 / 500 RPM	
BMDA 80 A4/12	0.25 0.05	1425 435	0.85 0.60	0.77 0.663	1.8 1.9	3.7 1.6	160	4300 8000	19.05	10	47 43	12.0
BMDA 80B4/12	0.37 0.07	1425 435	1.05 0.75	0.77 0.63	1.8 1.9	3.7 1.6	160	4200 8000	22.86	10	47 43	13.0
BMDA 90 SA4/12	0.40 0.13	1360 380	1.25 1.05	0.73 0.59	2.5 2.0	3.5 1.6	190	3200 6100	31.52	20	55 44	16.5
BMDA 90 LA4/12	0.55 0.18	1400 400	1.65 1.20	0.76 0.64	2.5 1.8	3.5 1.6	190	3000 5900	41.67	20	55 44	19.5
BMDA 90 LB4/12	0.75 0.22	1370 400	2.05 1.60	0.76 0.65	2.5 2.0	3.5 1.6	190	2850 5700	48.21	20	55 44	20.5
BMDA 100 LA4/12	0.90 0.25	1440 450	2.30 2.10	0.76 0.50	2.2 1.8	5.3 1.7	250	1950 4700	80.76	40	57 47	26
BMDA 100 LB4/12	1.10 0.35	1440 450	2.80 2.60	0.76 0.50	2.2 1.8	5.3 1.7	250	1850 4500	92.55	40	57 47	28
BMDA 112 MB4/12	1.50 0.45	1420 440	3.40 2.40	0.84 0.55	2.2 2.0	6.0 2.2	470	780 4300	200.60	60	75 61	39
BMDA 132 SA4/12	2.50 0.80	1440 440	5.40 3.80	0.81 0.53	2.7 1.6	7.0 2.4	600	400 1100	304.90	100	75 62	67
BMDA 132 MA4/12	3.00 1.00	1440 440	6.40 4.50	0.81 0.53	2.7 1.6	7.0 2.4	600	400 1100	360.70	100	75 62	71
BMDA 132 MB4/12	4.00 1.30	1140 440	8.50 5.90	0.81 0.55	2.7 1.6	7.0 2.4	600	400 1100	467.70	100	75 62	82
BMDA 160 MB4/12	4.80 1.60	1425 455	10.00 7.20	0.89 0.57	2.8 2.0	7.5 3.0	700	300 850	867.00	150	63 61	138
BMDA 160 LB4/12	7.30 2.40	1410 445	15.20 10.10	0.90 0.61	2.8 2.0	7.0 3.0	700	300 850	1160.00	150	63 61	156

1. Motor characteristic values reported in the tables refer to continuous duty (S1), 50 Hz frequency, ambient temperature max. 40 °C, altitude up to 1000 m. above sea level operating condition.

2. The expressed brake torque is the max admissible one.

Brake current consumption values refer to a rated voltage of 230V AC single-phase.

3. The table shows the sound pressure noise level, measured at one metre range from the motor according to the Acurve (ISO 1680). The shown noise levels refer to motor no-load

operating condition and should be regarded with a tolerance of ± 3dB.

4. The rated torque T_n (Nm) for motors can be calculated as follow: $T_n (Nm) = \frac{9.55 \times P_n (W)}{RPM}$

Type	56	63	71	80	90S	90L	100L	112M	132S	132M	160M	160L
A	90	100	112	125	140	140	160	190	216	216	254	254
B	71	80	90	100	100	125	140	140	140	178	210	254
C	36	40	45	50	56	56	63	70	89	89	108	108
D	9	11	14	19	24	24	28	28	38	38	42	42
d	M3	M4	M5	M6	M8	M8	M10	M10	M12	M12	M16	M16
E	20	23	30	40	50	50	60	60	80	80	110	110
Fa	6.6	9.5	9.5	11.5	11.5	11.5	14	14	14	14	18	18
Fb	M5	M5	M6	M6	M8	M8	M8	M8	M10	M10		
f	3	4	5	6	8	8	8	8	10	10	12	12
g	7.2	8.5	11	15.5	20	20	24	24	33	33	37	37
H	56	63	71	80	90	90	100	112	132	132	160	160
h	3	4	5	6	7	7	7	7	8	8	8	8
I	6	7	7	10	10	10	12	12	12	12	14.5	14.5
K	11	10.5	10.5	14	14	14	16	16	22	22	24	24
L	119	130	145	162	171	196	217	229	255	293		
L 1		166	182	194	207	232	254	262	294	339	373	395
Ma	100	115	130	165	165	165	215	215	265	265	300	300
Mb	65	75	85	100	115	115	130	130	165	165		
Na	80	95	110	130	130	130	180	180	230	230	250	250
Nb	50	60	70	80	95	95	110	110	130	130		
Oa	3	3	3.5	3.5	3.5	3.5	4	4	4	4	5	5
Ob	2.5	2.5	2.5	3	3	3	3.5	3.5	3.5	3.5		
Pa	120	140	160	200	200	200	250	250	300	300	350	350
Pb	80	90	105	120	140	140	160	160	200	200		
Q	230	260	295	334	360	385	435	470	565	604	690	734
R	75	80	80	80	98.5	98.5	98.5	98.5	108	108		
R1		135	135	135	170	170	170	170	199	199	268	268
S	8	10	10	12	12	12	14	14	15	15	15	15
V	7	7	8	9.5	10.5	10.5	12.5	13.5	16	16	21	21
W	93	97	105	113	127	127	138	158	198	198	155	155
W 1		111	121	130	148	148	162	176	210	210	246	246
Y	110	121	136	153	178	178	198	219.5	255	255	293	293
Z	75	75	75	75	98.5	98.5	98.5	98.5	108	108		
Z 1		86	86	86	112	112	112	112	151	151	167	167

B3 (Foot Mounting)

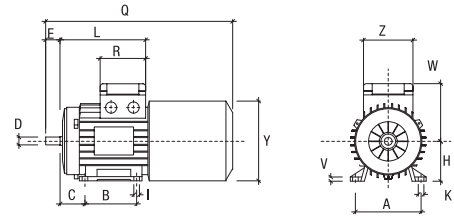

B5 (Flange Mounting)

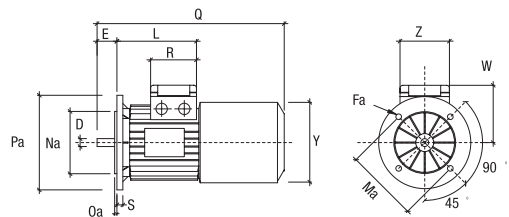

B14 (Face Mounting)

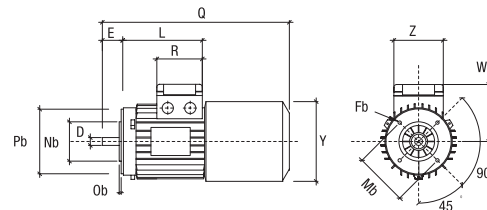

Double Terminal Board Box

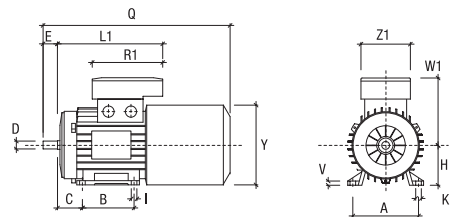

Size 160 B3 (Foot Mounting)

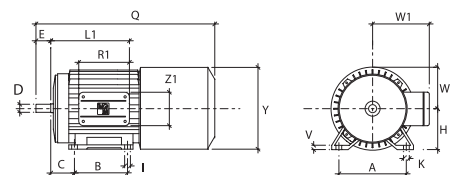

Shaft End

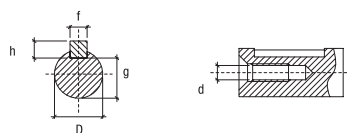

Note Cable glands are M 16 on size 56 up to 63
 M 20 on size 71 up to 80
 M 25 on size 90 up to 112
 M 32 on size 132
 PG 29 on size 160

Traverse motors with progressive start and stop

A few problems such as swinging of suspended loads, slipping of trolley wheel on rails, the breakage of some delicate mechanisms can occur on traverse applications. All these problems can be solved using progressive start/stop systems such as clutches, hydraulic couplings, slip-ring motors or soft start devices. Experience has shown that progressive start/stop brake motor is a valid alternative to all the other adducted systems. Traverse motors are provided with a flywheel whose dimension and weight are calculated in order to have an adequate moment of inertia. The ratio of rated torque to starting (locked rotor) torque is calculated in order to achieve the best progressive performance.

The flywheel accumulates energy during the start and gives it back during the stop resulting in a progressive change of the rotating speed. PV series motors don't need adjustments with load change or any special maintenance and the progressive action is directly proportional to the load increase. During the planning stage it is necessary to carefully choose the proper motor power as an insufficient power could cause overheating while a too powerful motor could reduce the effect of the flywheel progression.

PV series motors are designed with a special rotor to reduce the starting (locked rotor) current so to allow heavy start/stop duty cycle, even if the starting period doesn't have to be too long in order to avoid overheating.

BAPV series motors provide a reduced brake torque, resulting in a really progressive braking action. The brake torque of BAPV motors is about the half of the corresponding BA standard brake motors while BM and BMPV series motors have the same brake torque.

BAPV motors are fitted with a flywheel strongly secured to the motor shaft while BMPV motors are fitted with cast-iron cooling fan replacing the thermoplastic one.

PV series motors are available with the following features or option:

- Separate brake supply,
- Manual brake release,
- Suitable for mounting in any position (vertical, horizontal, etc.)
- Two speeds

The table below shows the moment of inertia increase (Kgm²) for BAPV and BMPV series.

Motor Type	63	71	80	90	100	112	132
BAPV	-	$2.97 \cdot 10^{-3}$	$6.78 \cdot 10^{-3}$	$1.11 \cdot 10^{-2}$	$1.82 \cdot 10^{-2}$	$2.89 \cdot 10^{-2}$	$5.8 \cdot 10^{-2}$
BMPV	$3.1 \cdot 10^{-4}$	$1.93 \cdot 10^{-3}$	$3.12 \cdot 10^{-3}$	$9.97 \cdot 10^{-3}$	$1.52 \cdot 10^{-2}$	$1.52 \cdot 10^{-2}$	-

The total moment of inertia of a chosen motor is the moment of inertia of a standard brake motor (see motors technical data) plus the flywheel moment of inertia (shown in table above).

Example: moment of inertia of BAPV 71 B4 = moment of inertia of BA 71 B4 + flywheel type BAPV 71 B4 moment of inertia = $8.1 \cdot 10^{-4} + 2.97 \cdot 10^{-3} = 3.78 \cdot 10^{-3}$ Kgm².

The table below shows the maximum brake torque (Nm) for BMPV with DC brake and BAPV motors with AC brake or DC brake:

Motor Type	63	71	80	90	100	112	132
BMPV	5	5	10	20	40	60	-
BAPV - A.C.	-	7	9	19	25	40	75
BAPV - D.C.	-	4,5	7,5	15	21	30	60

BAPV series

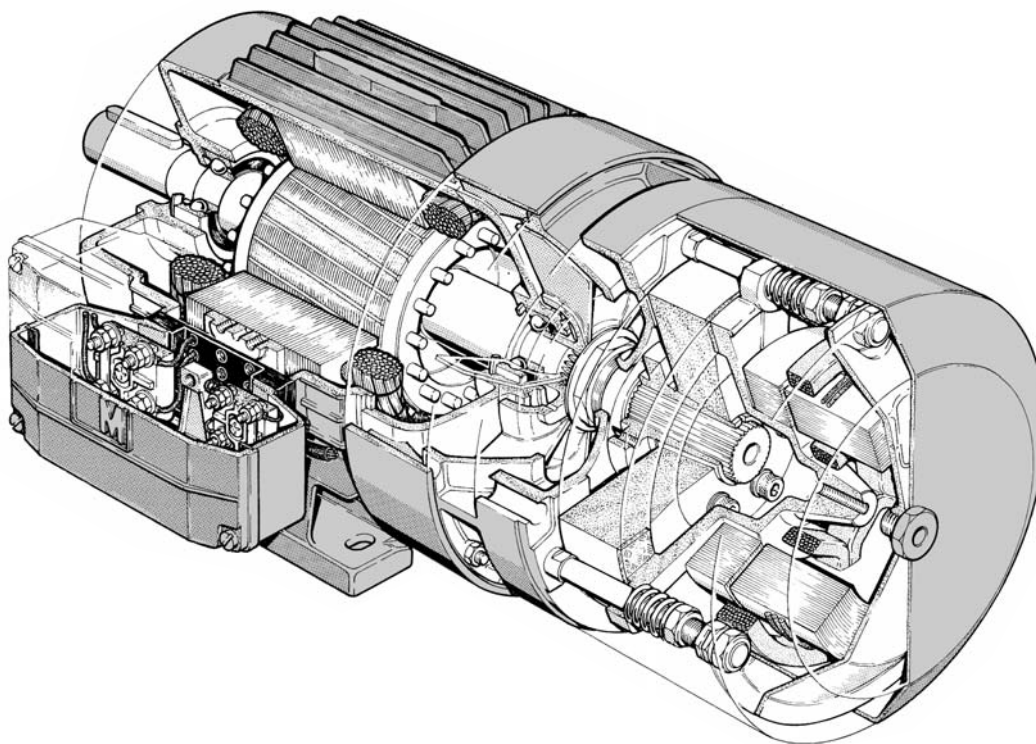

BMPV series

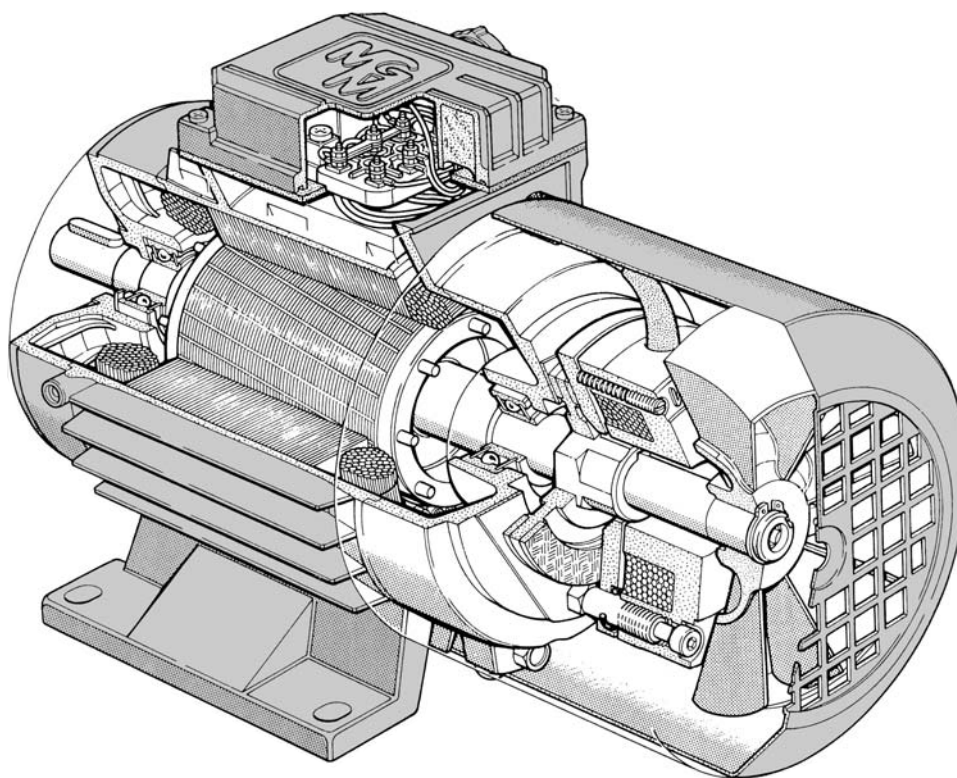

Hoisting Motors

BAPK series motors are available starting from 100 up to 225 frame size. Powers and poles are the same as the BA series motors (see BA technical data).

BAPK series motors have the same motor construction as BA series motors but present some special parts. Single and most-off the two speed BAPK motors are fitted with a special rotor (P rotor) that increases the starting (locked rotor) torque by 20% about and that reduces the starting (locked rotor) current by 10% about.

The brake disc nucleus and hub are made of steel (see k brake disc section). AC brake coil is provided to secure a fast brake intervention. Feet are frame integrated on B3 mounting (foot mounted) and not simply attached to the frame. This feature guarantee best reliability of brake motors for hoist application. Shields and flanges are made of cast iron. Frame is made of aluminium from 100 up to 132 frame size (132 cast iron frame is available on request) while it is made of cast iron starting from 160 frame size.

Dimensions are the same as the BA series (dimensions sheet pag. 34). To purchase BAPK series motors the writing BAPK have to be clearly stated in the order (i.e. BAPK 112 MB4/16).

K Brake Disc

Nucleus and hub of K brake disc are made of steel that means a higher sturdiness and moment of inertia. The K brake disc is provided as standard on motors starting from 160 up to 225 frame size while it's available on request on motors from 100 up to 132 frame size.

BA standard brake motors up to 132 frame size are made of a special aluminium/thermoplastic material.

K brake disc is strongly recommended for hoisting application or under high environment temperature (50°C or above).

K brake disc have a shorter lasting than standard brake disc as a consequence of the increased moment of inertia therefore it's advisable to use standard brake disc on heavy start/stop duty cycle application where the K disc is not necessary to purchase motors with K brake disc, the writing BAK have to the clearly stated in the order (i.e. BAK 112 MB4).

Premium Brake Torque Motors – BAF series

BAF series motors are brake discs motors providing a very high brake torque. BAF series motors are particularly suitable for those applications where it's needed to keep the motor locked up also under a very high turning moment. BAF series motors are provided with AC brake. BAF motors are available starting from 100 up to 225 frame size. The table below shows the BAF series brake torque values.

Motor Type	BAF 100	BAF 112	BAF 132	BAF 160	BAF 180	BAF 200	BAF 225
Brake Torque Max (Nm)	75	120	225	285	450	450	600

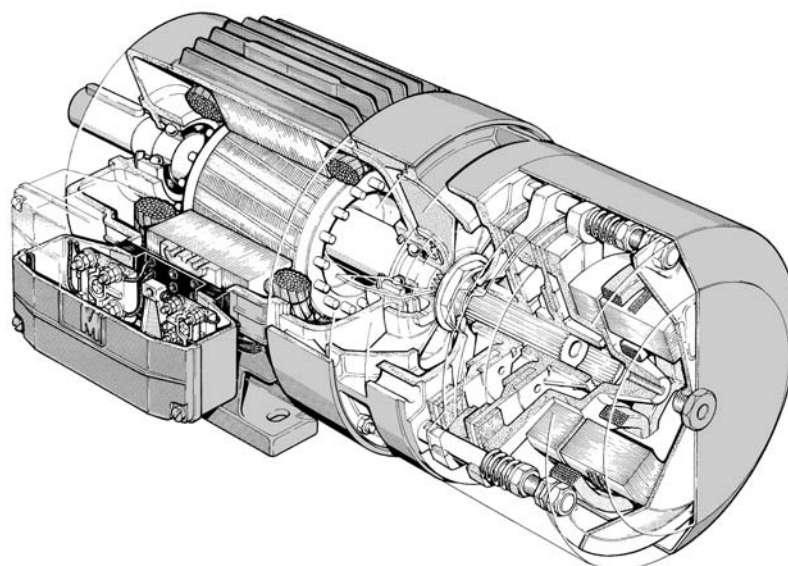

AC electric motors operating in non standard conditions (low frequency inverter duty, long overcharge periods, heavy duty cycles) could need additional cooling servo-fan. BASV series motors with forced cooling are provided with two additional cooling servo-fans fixed on the motor frame. This cooling system is an MGM patent.

SV series motors have the following features:

1. The standard self cooling fan inside the motor is kept additionally to the two cooling servo-fans.
2. The whole heating surface is increased as the fan fixing system is itself a heat dissipation element additionally to the existing fins on the frame.
3. Low noise level.
4. No additional motor length compared to the standard one.
5. Manual brake release with manual rotation.
6. Uniform winding cooling along the whole motor length.
7. The brake friction surface is cooled on the motor side.

Where the forced cooling is used to limit the operating temperature in heavy start/stop duty application, it should be noted that the efficiency of the forced cooling increases with the number of poles of the motor. It's hard to estimate the amount of hot air removed by the forced cooling fans but it can be roughly said that it is the same as the air removed by the standard servo-fan of a 4 pole motor operating at 50 Hz.

It is advisable to use thermal protectors in heavy operating conditions. The table below shows technical details of fans supplied at 230V single-phase. Motor can be supplied both at 50Hz or 60Hz. On request forced cooling fans can be provided with different voltage supply. BMAV series motors with forced cooling are provided with single axial servo-fan replacing the standard motor self cooling fan.

Motor Type	Dim X	Dim Y	Dim L	Volt	Amp	m ³ /h	dB (A)
BASV 71	210	107	102	230	2x0.1	93	37
BASV 80	230	108	120	230	2x0.1	93	37
BASV 90	270	129	129	230	2x0.12	300	39
BASV 100	280	129	134	230	2x0.12	300	39
BASV 112	300	142	142	230	2x0.12	300	39
BASV 132	348	169	169	230	2x0.12	615	59
BASV 160	431	184	190	230	2x0.30	615	59
BASV 180	485	211	211	230	2x0.30	615	59
BASV 200	485	211	211	230	2x0.30	615	59
BASV 225	522	221	221	230	2x0.30	615	59

BASV Series

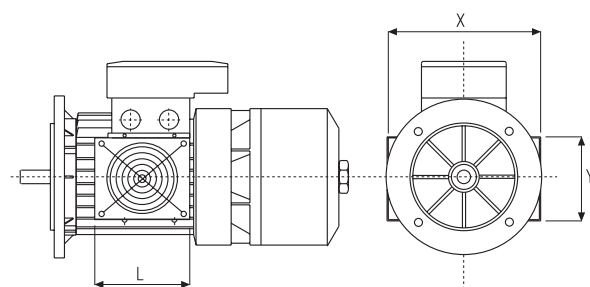

Built-in Encoder Motors

BAE-BMEAV series

Built-in Encoder Motors

Motors with built-in encoder represent a revolutionary component in the automation field providing OEM and end user with new opportunities and with notable economic advantages due to its user-friendly design. The range of three phase asynchronous motors with built-in encoder has been designed specifically to offer to the end user a comprehensive choice of an already widely tested motor with superior quality.

MGM motors with integrated encoder can be divided in two series of brake motors (BAE/BMEAV) and two series of standard motors (SAE/SMEAV) without brake. The power range starts from 0.06 kW up to 45 kW (frame size from 56 up to 225). The unit consists of a three phase asynchronous high efficiency motor with a low moment of inertia and with the encoder located at the Non-Drive side.

Motors are designed to be suitable for inverter use. Precise dynamic balancing together with an accurate motor insulation system are adopted in order to withstand electrical and mechanical stress. The mechanical coupling is the same standard motors (special shaft and flange are available on request), wirings are very simple to be made: power and electrical signal duly separated. MGM motors with integrated encoder can be supplied in conformity with requirements of standards UL 1004 "Electric motors" and CSA C 22.2 No. 100-95 "Motors and generators" (cCSAus approval).

MGM provides 4 different motor series suitable to meet accurately all possible drives challenges.

BAE series: asynchronous three phase fan cooled brake motors with built-in encoder and frame size from 71 up to 225. The encoder is located at the Non-Drive side in a safe place protected by a well closed cover. Forced ventilation is available on request. The motor is provided as standard with separate brake supply. The brake coil is AC as standard, while DC is available on request.

BMEAV series: asynchronous three phase brake motors with DC brake with axial forced ventilation, built-in encoder and frame size from 63 up to 160. The encoder is located at the non drive end side between the brake and the servo fan. The motor is supplied as standard with separate brake supply. Side manual return brake release available on request.

SAE series: asynchronous three phase fan cooled motors with built-in encoder and shaft heights between 71 mm and 225 mm. The encoder is located at the non drive end side in a safe place protected by a well closed cover. On request it's available with forced ventilation.

SMEAV series: asynchronous three phase motors equipped with forced ventilation with built-in encoder and frame size from 71 up to 225. The encoder is located at the non drive end side inside the fan cover between the motor and the forced cooling fan.

Encoder

The encoder is a rotational transducer to convert an angular movement into a series of electrical digital impulses. Usually the encoders used on MGM motors are based on the working principle of the angular movement transduction. The reading system is based on the rotation of a radial graduated disc formed by opaque windows alternated with transparent ones. This system is all illuminated in perpendicular way by an infrared light source, so the light projects the disc image on the surface, which is covered by a grating, having the same step as the disc.

The receiver converts the light variations occurring with the disc shifting into their corresponding electrical variations. Incremental encoder position is determined by the number of impulses from the zero index; Absolute encoder position is determined by an output position code which is univocally determined within each encoder revolution. To exactly identify the incremental encoder, the following characteristics have to be indicated:

- Resolution
- Impulse of Zero
- Power supply
- Electronic output configuration

To identify absolute encoders are additionally required:

- Code
- Single turn or Multi turn

The output cable is provided as standard without connector (floating cable). On request a connector can be supplied. Please contact MGM for further information.

Cooling

Motor cooling is usually assigned to the motor self-cooling fan (BAE and SAE series). BMEAV and SMEAV series are forced cooling motors. On request the BMEAV and SMEAV series motors can be provided without forced ventilation (BME and SME series self-cooled motors).

On request BAE and SAE series motors can be provided with radial forced ventilation (BAESV and SAESV series) with two servo fans fixed on the frame, additionally to the standard self cooling fan located at the Non-Drive and side.

BAE Series Dimensions

Dimension	71	80	90S	90L	100L	112M	132S	132M	160M	160L	180L	200L	225S	225M
A	112	125	140	140	160	190	216	216	254	254	279	318	356	356
B	90	100	100	125	140	140	140	178	210	254	279	305	286	311
C	45	50	56	56	63	70	89	89	108	108	121	133	149	149
D*	14	19	24	24	28	28	38	38	42	42	48	55	60	60
d	M5	M6	M8	M8	M10	M10	M12	M12	M16	M16	M16	M16	M16	M16
E*	30	40	50	50	60	60	80	80	110	110	110	110	140	140
Fa	9,5	11,5	11,5	11,5	14	14	14	14	18	18	18	18	18,5	18,5
Fb	M6	M6	M8	M8	M8	M8	M10	M10						
f	5	6	8	8	8	8	10	10	12	12	14	16	18	18
g	11	15,5	20	20	24	24	33	33	37	37	42,5	49	53	53
H	71	80	90	90	100	112	132	132	160	160	180	200	225	225
h	5	6	7	7	7	7	8	8	8	8	9	10	11	11
I	7	10	10	10	12	12	12	12	14,5	14,5	15	18,5	18	18
K	10,5	14	14	14	16	16	22	22	24	24	24	30	33	33
L1	184	194	207	232	254	262	294	339	373	395	420	446	452	464,5
Ma	130	165	165	165	215	215	265	265	300	300	300	350	400	400
Mb	85	100	115	115	130	130	165	165						
Na	110	130	130	130	180	180	230	230	250	250	250	300	350	350
Nb	70	80	95	95	110	110	130	130						
Oa	3,5	3,5	3,5	3,5	4	4	4	4	5	5	5	5	5	5
Ob	2,5	3	3	3	3,5	3,5	3,5	3,5						
Pa	160	200	200	200	250	250	300	300	350	350	350	400	450	450
Pb	105	120	140	140	160	160	200	200						
Q	415	451	483	507	558	576	677	715	803	847	931	956	1082	1103
q	76	76	76	76	76	76	76	76	76	76	76	76	112	112
R1	135	135	170	170	170	170	199	199	268	268	268	268	268	268
S	10	12	12	12	14	14	15	15	15	15	15	15	16	16
V	8	9,5	10,5	10,5	12,5	13,5	16	16	21	21	24	24	30	30
W									165	165	188	188	215	215
W1	121	130	148	148	162	176	210	210	246	246	266	266	321,5	321,5
Y	145	160	180	180	196	218	265	265	324	324	357	357	430	430
Y1	121	121	121	121	121	121	121	121	121	121	121	121	158	158
Z1	86	86	112	112	112	112	151	151	167	167	167	167	167	167

* 225S-225M 2 poles D=55, E=110

B3 (Foot Mounting)

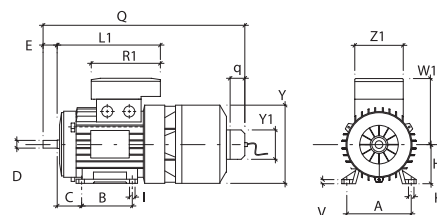

B5 (Flange mounting)

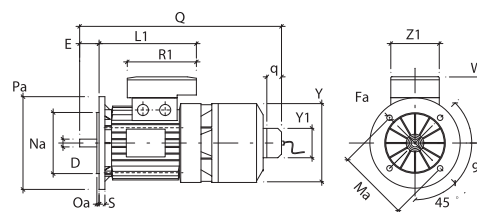

B14 (Face Mounting)

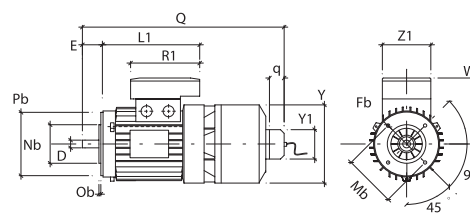

Size 160/180/200/225 B3 (Foot Mounting)

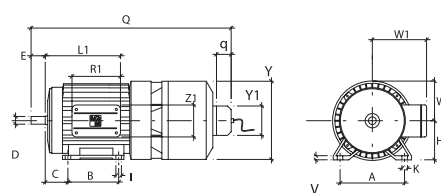

Double Terminal Board Box

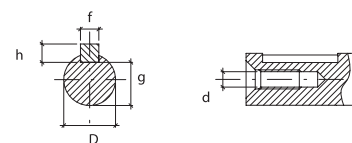

BMEAV Series Dimensions

Dimension	63	71	80	90S	90L	100L	112M	132S	132M	160M	160L
A	100	112	125	140	140	160	190	216	216	254	254
B	80	90	100	100	125	140	140	140	178	210	254
C	40	45	50	56	56	63	70	89	89	108	108
D	11	14	19	24	24	28	28	38	38	42	42
d	M4	M5	M6	M8	M8	M10	M10	M12	M12	M16	M16
E	23	30	40	50	50	60	60	80	80	110	110
Fa	9,5	9,5	11,5	11,5	11,5	14	14	14	14	18	18
Fb	M5	M6	M6	M8	M8	M8	M8	M10	M10		
f	4	5	6	8	8	8	8	10	10	12	12
g	8,5	11	15,5	20	20	24	24	33	33	37	37
H	63	71	80	90	90	100	112	132	132	160	160
h	4	5	6	7	7	7	7	8	8	8	8
I	7	7	10	10	10	12	12	12	12	14,5	14,5
K	10,5	10,5	14	14	14	16	16	22	22	24	24
L1	166	184	194	207	232	254	262	294	339	373	395
Ma	115	130	165	165	165	215	215	265	265	300	300
Mb	75	85	100	115	115	130	130	165	165		
Na	95	110	130	130	130	180	180	230	230	250	250
Nb	60	70	80	95	95	110	110	130	130		
Oa	3	3,5	3,5	3,5	3,5	4	4	4	4	5	5
Ob	2,5	2,5	3	3	3	3,5	3,5	3,5	3,5		
Pa	140	160	200	200	200	250	250	300	300	350	350
Pb	90	105	120	140	140	160	160	200	200		
Q	310	345	384	410	435	485	520	625	664	690	734
R1	135	135	135	170	170	170	170	199	199	268	268
S	10	10	12	12	12	14	14	15	15	15	15
V	7	8	9,5	10,5	10,5	12,5	13,5	16	16	21	21
W										155	155
W1	111	121	130	148	148	162	176	210	210	246	246
Y	121	136	153	178	178	198	219,5	255	255	310	310
Z1	86	86	86	112	112	112	112	151	151	167	167

B3 (Foot Mounting)

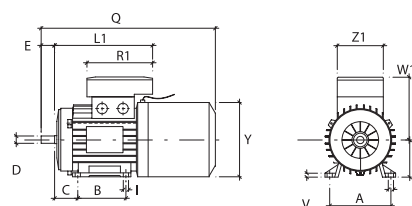

B5 (Flange Mounting)

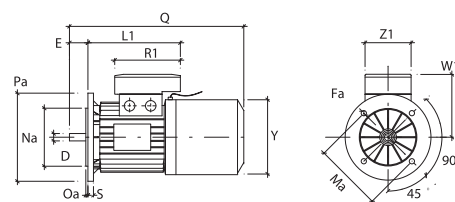

B14 (Face Mounting)

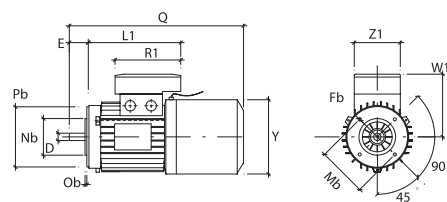

Double Terminal Board Box

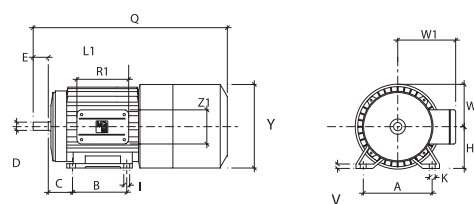

Shaft End

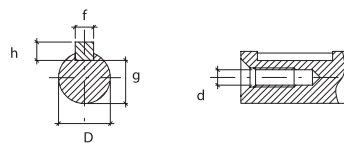

Built-in inverter motors consist of three-phase asynchronous electric motors with integrated frequency inverter. Power range is between 0,37 kW and 15,0 kW while the motor frame is from 71 up to 160. The unit is made up of a high-efficiency 3-phase asynchronous electric motor and a compact frequency inverter placed at the non-drive motor end. The basic construction is closed, fan cooled and IP 55 enclosure duty. Built-in inverter motor is able to properly run also under heavy overload conditions thanks to a high thermal reserve; the insulating materials are class F. The frame is made of aluminium alloy up to 132 frame size and of cast iron for above sizes. Shields and flanges are made of aluminium up to 90 frame size and of cast iron up to 160 frame size. The inverter housing is isolated from the motor in order to avoid heat transmission (patented system); the inverter heat sink is self-ventilated. The frequency converter provided is one of the most advanced in design concept as well as used components; control can be chosen between V/F type (frequency voltage control) or SLV type (Sensorless Vector Control). Built-in inverter motors are easy to be programmed using only three buttons. Some functions, which automatically set parameters (acceleration/deceleration times, V/f ratio etc.), make the programming easier. On request, motor can be arranged for main Bus fields (Profibus, Interbus-S, Device-Net, etc.). Built-in inverter motors are designed to be real built-in frequency converter motors and not just as a simple assembly of a standard motor with an inverter. The wiring connection is definitely simple to be made. All the adducted features make the built-in inverter motor series high performance with strong structure.

Benefit and Applications

Built-in inverter motors represent an innovation in the automation field and they give manufacturers, automation designers and machinery users new opportunities and great economical advantages. The ease of installation, the simple structure and the cost-effectiveness of the system are pointed out as follows. Overall dimensions are extremely reduced; the couplings are the same as those of a standard motor (special flanges and shafts can be supplied on request); Protection class is IP 55 as standard (IP 56 is available on request); Electrical connections are extremely simplified; power and control are totally separated and placed on different terminal boards; On request, motor can be equipped with built-in EMI filter (class A or B) in the way to avoid an external filter application; the motor connection can be carried out through normal power supply cables, as shielded cables are no longer necessary in order to comply with EMC regulations; SMI series motor can immediately replace a mechanical speed variator, offering more advantages; The system performance is very high in every operating condition; Unit switchboard on which SMI motor is installed can be removed or reduced as the inverter has no longer to be housed. SMI motor represents the solution to the actual needs related to automation systems where actuating and surveying devices can find more places on unit board so to reduce the panel overall dimensions and the wiring costs.

Built-in inverter motors

Main Specifications

Power range

0.37 - 0.75 kW (single-phase) 0.75 - 15.0 kW (three-phase)

Supply voltage

1x200-240 V 50/60 (single phase)

3x380-460 V 50/60 (three-phase)

Protection class (enclosure duty)

IP 55 (IP56 on request)

Mounting

IM B3-foot mount, IM B5-flange mount, IM B14-face mount (shaft/flange reduced/increased on request)

Type of control

V/F frequency voltage control (letter x behind the motor plate)

SLV sensorless vector control (letter V behind the motor plate)

Speed adjustment range

3-150 Hz for version X (frequency voltage control)

1-150 for version V (vector control without sensor)

Analog input

0-10 V D.C. 4-20 mA

Digital input

5 programmable with 14 functions (for versions X)

6 programmable with 19 functions (for versions V)

Digital output

- 1 programmable relay - only alarm (exchange contact 250 V AC 2.5 A) version X

- 1 programmable relay with 6 functions version V

- 2 outputs with programmable transistors with 6 functions (open collector 27 V 50 mA)

Serial interface

RS 422 as standard for parameters loading/unloading

RS 485 multidrop for automation by external module

Protection functions

Over-current, over-voltage, low voltage, overloading, exceeding operation temperature, CPU error, starting phase earthed protection

Options

Forced cooling

It allows a wider application of built-in inverter motors. It can be required at the time of the purchase or in case installed afterwards, buying the proper kit.

Thermal protection devices

they can be inserted into the motor and controlled by the inverter logic

External potentiometer

it can be built-in (allowing the speed regulation directly on the motor)

Remote control panel

SMI motor can be also controlled through a remote keyboard. The keyboard is equipped with parameter copy function

Built-in EMI filters

Class A (industrial application)

Class B (residential application)

Braking dynamic resistance

it can be fitted in the version with vector control

Field bus

it can be arranged for the main commercial buses (Profibus, Interbus-S, Device Net, etc.)

BMBM Series

BMBM series consist of three phase AC brake motors with twin DC brakes working independently of each other, starting from 71 up to 200 frame sizes and power range from 0.18 kW up to 37 kW.

BMBM series main feature is a very high reliability in those lifting applications where there are high demands of safety and quiet. For these reasons BMBM series motors are particularly suitable to be used for TV-cine studios and theatre's stages.

The motor brakes in case of power supply failure. The braking action is always secured through a very quick and precise stop assuring a safe and a prompt stop in case of unintentional power supply failure. The brake components and assembly are designed with special features to be noiseless during stops, granting the high ratings of EN81.

The manual brake release is made up of two levers (one for each brake) so to avoid unwanted starts. It's possible to release the brake just using one hand.

The two brakes are supplied through independent rectifiers which are positioned in the terminal box.

Rectifiers are provided with over-voltage protection device and with EMC filter.

It's possible to have two types of wirings connection to the rectifier for each brake, in relation to the intervention time required.

All BMBM series motors are suitable for inverter use; on request, it's possible to have the motor with a built-in encoder or to have the motor ready for the encoder to be easily mounted.

The brake disk friction material is asbestos free and the brake lining has a high friction factor and is long-lasting.

The winding insulation class is F. Class H is available upon request. Motor construction type is Totally Enclosed Not Ventilated, TENV with IP 54 enclosure rating (IP 55 and external cooling are available upon request).

BMBM series motors tolerate a high overload level and being not self-cooled have to be used on intermittent duty only.

On request it's possible to provide motors with thermo-protection devices.

Frame is made of die cast, light metal on motors up to 132 frame size and of cast iron on motors from 160 up to 200 frame size.

Feet are frame integrated (they are not simply attached to the frame) on IM B3 mounting (foot mounted) as standard and it makes the motor very sturdy since this motors are used in critical applications.

Plates and flanges are made of aluminum up to 90 frame size and of cast iron for above sizes.

Frame size (mm)	Brake torque (Nm)	Power consumption (W)
71	2 x 3,5	2 x 22
80	2 x 7,0	2 x 28
90	2 x 14	2 x 34
100	2 x 28	2 x 42
112	2 x 42	2 x 50
132	2 x 70	2 x 64
160	2 x 107	2 x 76
180	2 x 187	2 x 100
200	2 x 300	2 x 140

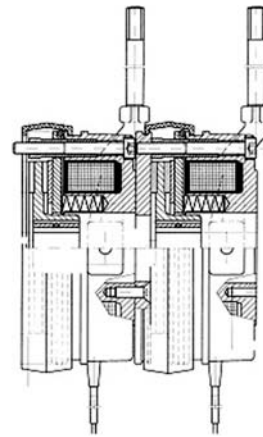

BMBM Series Dimension

Dimension	71	80	90S	90L	100	112	132S	132M	160M	160L	180L	200
A	112	125	140	140	160	190	216	216	254	254	279	316
B	90	100	100	125	140	140	140	178	210	254	279	305
C	45	50	56	56	63	70	89	89	108	108	121	133
D	14	19	24	24	28	28	38	38	42	42	48	55
d	M5	M6	M8	M8	M10	M10	M12	M12	M16	M16	M16	M16
E	30	40	50	50	60	60	80	80	110	110	110	110
Fa	9.5	11.5	11.5	11.5	14	14	14	14	18	18	18	18
Fb	M6	M6	M8	M8	M8	M8	M10	M10				
f	5	6	8	8	8	8	10	10	12	12	14	16
g	11	15.5	20	20	24	24	33	33	37	37	42.5	49
H	71	80	90	90	100	112	132	132	160	160	180	200
h	5	6	7	7	7	7	8	8	8	8	9	10
I	7	9	10	10	12	12	12	12	14	14	14	18
L1	180	194	207	232	254	262	248	260	314	337	399	424
Ma	130	165	165	165	215	215	265	265	300	300	300	350
Mb	85	100	115	115	130	130	165	165				
Na	110	130	130	130	180	180	230	230	250	250	250	300
Nb	70	80	95	95	110	110	130	130				
Oa	3.5	3.5	3.5	3.5	4	4	4	4	5	5	5	5
Ob	2.5	3	3	3	3.5	3.5	3.5	3.5				
Pa	160	200	200	200	250	250	300	300	350	350	350	400
Pb	105	120	140	140	160	160	200	200				
Q	303	342	380	405	456	491	567	605	719	763	832	873
R1	135	135	170	170	170	170	180	180	260	260	260	260
S	10	12	12	12	14	14	14	14	15	15	15	18
V	8.5	9.5	10.5	10.5	13	13.5	18	18	18	18	21	21
W1	120	131	148	148	162	176	196	196	267	267	277	277
Y	85	105	130	130	150	170	195	195	225	225	258	306
Z1	86	86	112	112	112	112	120	120	184	184	184	184

B3 (Foot Mounting)

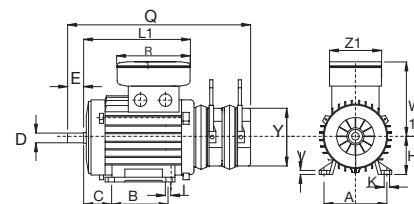

B5 (Flange Mounting)

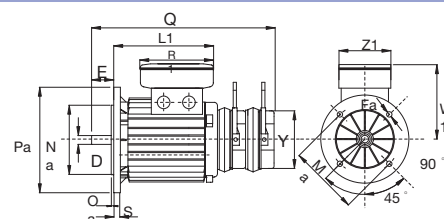

B14 (Face Mounting)

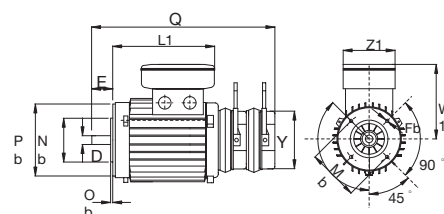

size 160 M/L 180L 200L - B3 (Foot Mounting)

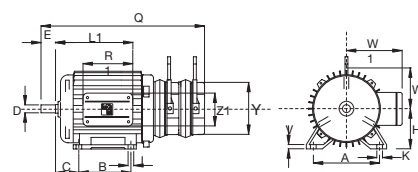

Shaft End

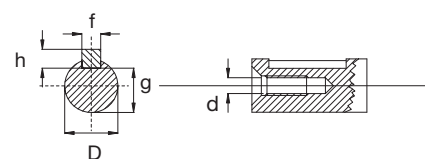

Frame size	71	80	90	100	112	132	160	180	200
Min air gap[mm]	0.2	0.2	0.3	0.3	0.3	0.4	0.4	0.5	0.5
Max air gap[mm]	0.7	0.8	0.8	0.9	1.0	1.1	1.1	1.2	1.2

MGM motors can be provided, on request, with cCSAus approval (in conformity with C22.2 No. 100 and UL 1004 standards). Motors with cCSAus approval show the  mark on the nameplate. Motors can be provided with two different type of windings: 6 leads winding and Δ/Y motor wiring (i.e. European standard) or 9 leads winding with Y/YY motor wiring (i.e. US standard 3x230/460V 60Hz).

BA series brake motors can be provided either with AC brake or with DC brake, while BM brake motors can provided with DC brake only.

It always necessary to indicate both the motor and the brake supply in the order.

SMX series

SMX motors are AC 3-phase totally enclosed fan cooled standard motors (without brake) matching the efficiency limit of USA (EPACT) and Canada standards regarding standard single speed motors starting from 1 HP up to 200 HP rated power. The applied efficiency calculation (IEEE 112 and CSA 390 standards) method is different from European method.

MGM laboratories are qualified to execute efficiency test according to the adducted methods in order to certify the efficiency level of motors. Motors complying with efficiency standards (IEEE 112 and CSA 390) show the MGM “certification Compliance Number” released by American Department of Energy (CC 051 A) and the EEV mark  from CSA on the nameplate. Please contact MGM for further details.

Motors for Australia and New Zealand

In Australia and New Zealand MEPS (Minimum Energy Performance Standard) fix the minimum efficiency limit on 3-phase single speed motors starting from 0.73 kW up to 185 kW rated power.

Two efficiency calculation methods are provided and two different efficiency limit respectively.

Method A is technically equivalent to IEEE112-B while method B is based on IEC 60034-2. This standard doesn't involve two speed or S2 duty. Please contact MGM for further details.

Motors for China

MGM motors can be provided, on request, with CCC certification that is the compulsory certification to sell motors in China. Certified motors show the  mark on the nameplate.

When motors with this certification are needed it is always necessary to indicate in the order “motors with CCC certification”.

MGM motors from 56 up to 225 frame size are individually packed in a box which externally reports the motor identification data. The table below shows the boxes dimension for each size. Motors with frame size 160 up to 225 are fixed down to pallets with squared timbers. Pallets have EURO overall dimension (120 x 80 cm).

Parcels are marked with stickers providing information about the final destination, customer number and address and production lot number. Additional protective materials as cardboard and shrink film around the pallet are used for sea and air shipments.

Motor type	Depth (cm)	Width (cm)	Height (cm)
Brake motor frame size 56	38	19	22
Brake motor frame size 63	38	19	22
Brake motor frame size 71	38	19	22
Brake motor frame size 80	49	23	27
Brake motor frame size 90	49	23	27
Brake motor frame size 100	54	29	29
Brake motor frame size 112	56	33	30
Brake motor frame size 132	69	34	42
Brake motor frame size 160*	93	63	52
Brake motor frame size 180*	93	63	52
Brake motor frame size 200*	93	63	52
Brake motor frame size 225	120	80	70

Motors highlighted with * can be delivered either inside a box or fixed on the pallet.

On request for high batch quantity of the same motor size it's possible to pack the motors directly in an single big box (MULTIPACK). Motors are arranged in carton layers in the way to protect goods integrity. The drawing here below shows the box overall dimension while the chart shows the batch quantity that can be inserted in each MULTIPACK box according to the frame size.

The stated quantity have to be considered approximate quantity as they change with the required motor mounting (B3, B5, B14 etc.).

Frame Size	Quantity
56-63	80
71	40
80	30
90	20

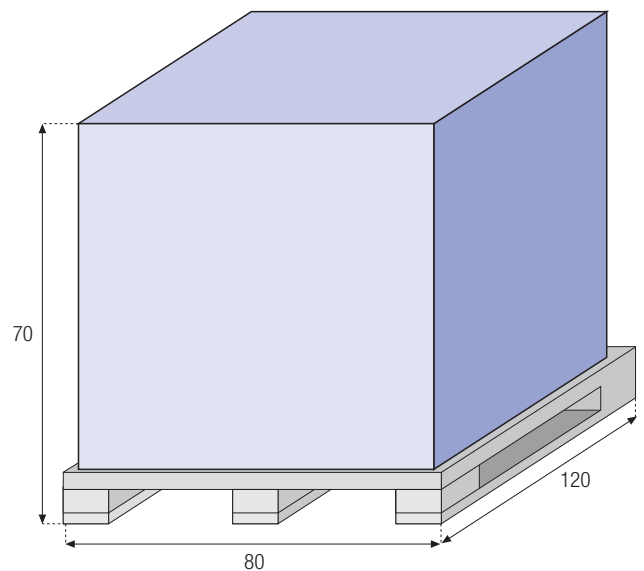

Terms and Conditions of Sale and warranty

All goods manufactured or supplied by M.G.M. motori elettrici S.p.A. shall be subject to MGM terms and conditions of sale and warranty listed on the MGM internet site <http://www.mgmrestop.com>.

The table below shows the available main special features and the options for MGM motors. Letter S stands for “Standard”, letter R stands for “on Request” and letter N stands for “uNavailable”.

Ref.	Description	BM	BA
1.	Non-standard flange	R	R
2.	Special motor shaft as per drawing	R	R
3.	Motors with feet and flange (IM B35 and IM B34 with corresponding vertical mounting)	R	R
4.	Balancing for reduced or special vibration level	R	R
5.	Separate brake supply (two different terminal boards) ¹	R	R
6.	IP 55 or IP 56 Enclosure rating (protection degree)	R	R
7.	Special motor/brake voltage or frequency supply	R	R
8.	Insulation Class H	R	R
9.	Brake torque and/or air gap pre-adjustment to desired value	R	R
10.	CSA approval 	R	R
11.	CCC approval 	R	R
12.	Special pole motors (not listed in this catalogue)	R	R
13.	Standstill heating	R	R
14.	Bimetallic thermal protectors	R	R
15.	Thermistors PTC	R	R
16.	Tropicalization treatment of motor windings	R	R
17.	Over-voltage safety cutout (RC04 and RC10)	R	R
18.	Terminal box on the right (left) side for IM B3 (BA 80-132)	N	R
19.	Double shaft end ²	R	R
20.	Test certificate	R	R
21.	Rain roof (BM), special fan cover for outside vertical mounting	R	N
22.	Brake cover (BA), special brake cover for outside vertical mounting	N	R
23.	Precise tolerance class	R	R
24.	Fan cover for textile environment ⁴	R	S
25.	Motor with built-in encoder or tachogenerator ²	R	R
26.	Motor arranged for manual rotation (shaft fitted with hexagonal hole at non-drive end) ³	S	S
27.	Special finishing (marine environment, washdown applications)	R	R
28.	Manual brake release key ²	N	S
29.	Manual return brake release lever	R	R
30.	T key for manual shaft rotation	R	R
31.	Stainless steel tie rods, bolts, nuts and screws	R	R
32.	Forced cooling motor (SV, AV series)	R	R
33.	Motor with additional cable gland holes	R	R
34.	Zinc plated brake surfaces	R	R
35.	Drain holes	R	R
36.	Stainless steel friction surface	R	R
37.	Brake release microswitch		
38.	Microswitch detector of brake disc wear		

1

Double terminal board box for brake separate supply is provided as standard on BM and BA two speed motors while it's on request only on single speed motors.

2

Brake manual release key is not provided as standard on BA motors with double shaft end or with encoder or tachogenerator.

3

Motor with frame size up to 132 are fitted as standard with hexagonal hole at non-drive end it is available on request on motors with frame size 160 and above.

4

BA series motors don't need the fan cover for textile environment.

M.G.M. motori elettrici S.p.A. is present in more than 40 countries around the world with sales/parts outlets and customer service. Please contact MGM customer assistance to find further information about MGM in the world. To clearly identify a spare part it is necessary to provide the item number (shown on the drawing below), the motor type, the rated voltage and frequency supply for electric parts such as the stator, the brake coil and the rectifier.

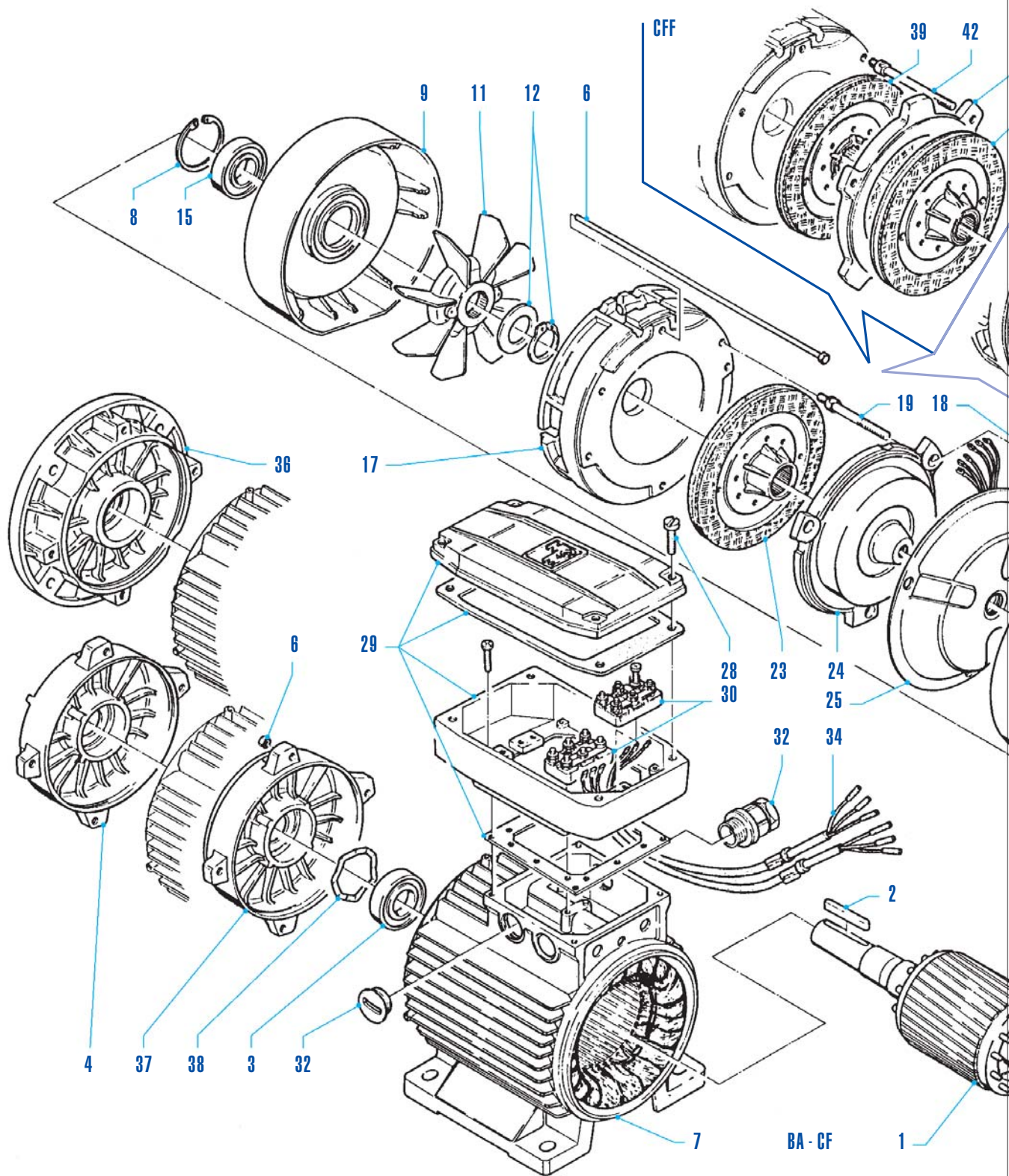

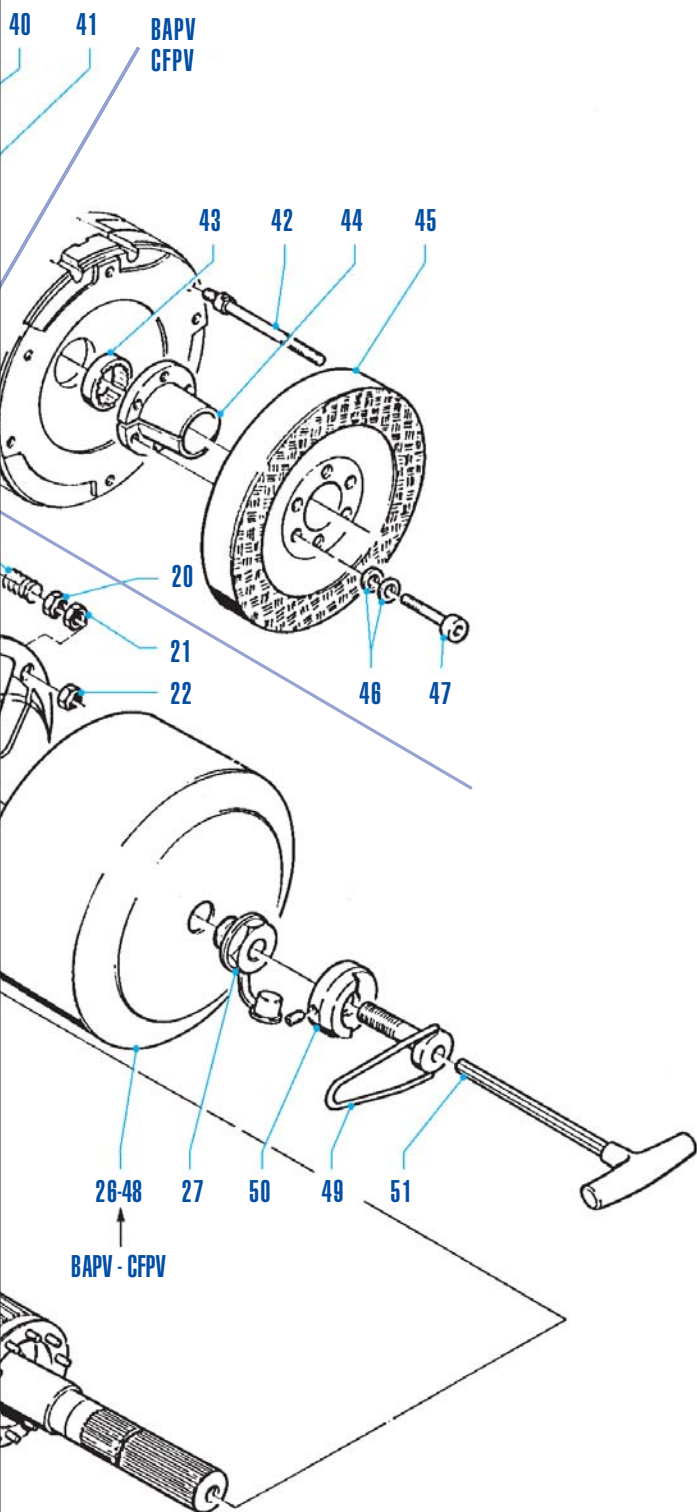

Complete rotor	1
Key	2
Bearing Drive End side	3
Endshield Drive End (front cover)	4
Tie rod assembly	6
Stator frame	7
Circlip	8
Endshield brake side (rear cover)	9
Fan	11
Fan fixing accessories	12
Bearing Non Drive Side	15
Brake Friction Surface	17
Spring	18
Brake adjuster	19
Brake torque adjuster locknut	20
Air gap adjusting nut	21
Brake coil locknut	22
Brake Disc	23
Brake Moving Element	24
Brake Coil	25
Brake Cover (BA-CF)	26
Hexagonal Rear Nut (socket head nut)	27
Terminal Box Screws	28
Terminal Box (single or double)	29
Terminal Board	30
Cable Gland	32
Brake Coil Connection Cables	34
Flange B5 (Flange Mounting)	36
Flange B14 (Face Mounting)	37
Elastic Washer	38
Brake Disc (BAF-CFF)	39
Additional Brake surface (BAF-CFF)	40
Additional Brake Disc (BAF-CFF)	41
Long Brake Adjuster (BAPV-BAF-CFF-CFPV)	42
Spacer (BAPV-CFPV)	43
Taper Bush (BAPV-CFPV)	44
Flywheel (BAPV-CFPV)	45
Elastic Washer (BAPV-CFPV)	46
Taper bush fixing screws (BAPV-CFPV)	47
Brake Cover (BAPV-BAF-CFPV-CFF)	48
Brake Release Screw	49
Fulcrum Hub for brake release (on request only)	50
Allen key for manual shaft rotation (on request only)	51

M.G.M. motori elettrici S.p.A. is present in more than 40 countries around the world with sales/parts outlets and customer service. Please contact MGM customer assistance to find further information about MGM in the world. To clearly identify a spare part it is necessary to provide the item number (shown on the drawing below), the motor type, the rated voltage and frequency supply for electric parts such as the stator, the brake coil and the rectifier.

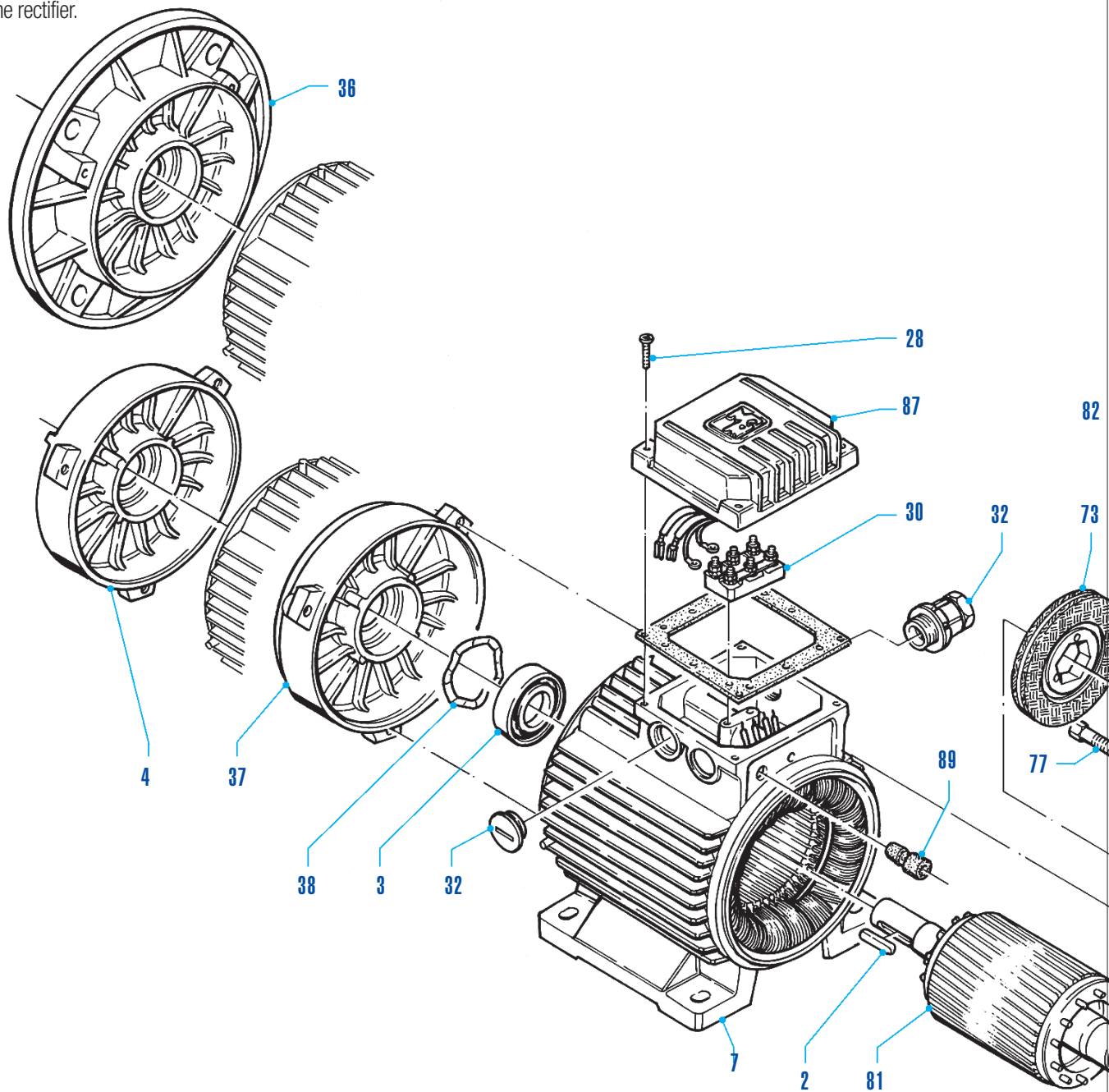

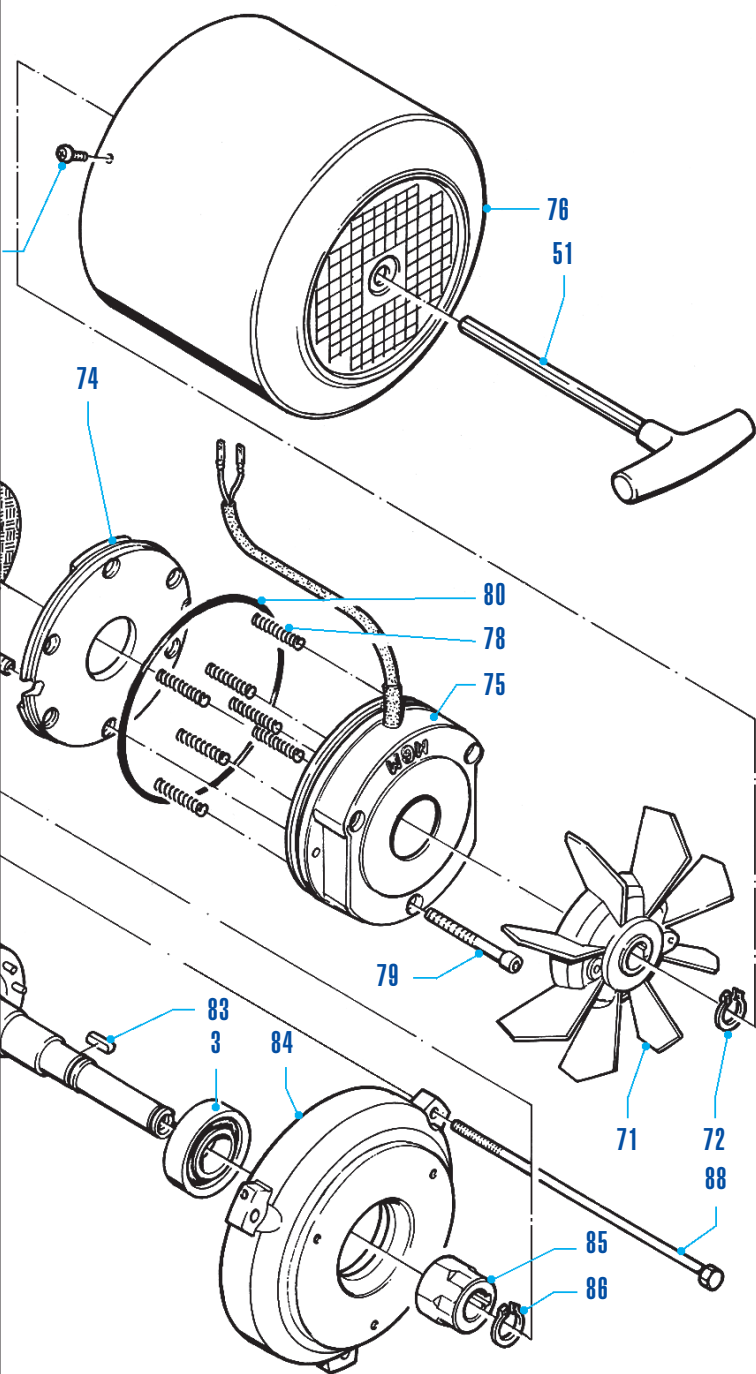

Key	2
Bearing Drive Side	3
Endshield Drive End	4
Stator Frame	7
Terminal Box screws	28
Terminal Box (single or double)	30
Cable Gland	32
Flange B5 (Flange Mounting)	36
Flange B14 (Face Mounting)	37
Elastic washer	38
Allen key for manual shaft rotation (on request only)	51
Fan	71
Fan Snap Ring	72
Brake Disc	73
Brake Moving Element	74
Brake Coil	75
Fan Cover	76
Connecting Screw	77
Adjustable or Fixed Springs	78
Brake Fixing Screw	79
Brake Assembly O-ring (BM 80-90-100)	80
Complete Rotor	81
Fan Cover Screw	82
Brake Assembly Key (BM 71-80-90-100)	83
Endshield Brake Side (rear cover)	84
Hexagonal Hub	85
Fixing Hub Snap Ring	86
Terminal Box with built-in rectifier	87
Tie Rod	88
Rubber Sleeve	89



COD. RIF. A05I0607

Please note that all data stated in this catalogue are subjected to change without notice

MGM motori elettrici spa has made every effort to make this catalogue complete and accurate as of the time of printing. Since products are continuously being improved, all data is subject to change or correction. The data presented here is for general information to provide an overview of MGM capabilities. For specific applications, installation and operating instructions, certified dimensions, capabilities and performance data, and pricing and availability, contact MGM staff.



M.G.M.
motori elettrici s.p.a.

Head office and production

I - 51030 Serravalle Pistoiese (PT)

S/R 435 Lucchese Km 31

Tel. +39 0573 91511 (r.a.)

Fax +39 0573 518138

Web www.mgmrestop.com

E-mail mgm@mgmrestop.com

North Italy branch office

I - 20090 Assago Milano - Via Fermi, 44

Tel. +39 02 48843593 - Fax +39 02 48842837

M.G.M.
electric motors NA Inc.

Head office and production

9731, Métropolitain Boulevard East

Montréal, Québec H1J 3C1 - Canada

Tel. +1 (514) 355 4343 - Fax +1 (514) 355 5199